

# CJ-series EtherNet/IP Unit

# CJ1W-EIP21

CSM\_CJ1W-EIP21\_DS\_E\_9\_1

## Introducing the New EtherNet/IP Unit. More Than 180,000 Words of Tag Data Link Capacity!

- EtherNet/IP is an industrial multivendor network that uses Ethernet. Managed by the ODVA (Open DeviceNet Vendors Association), it has open standards and is used with a wide range of industrial devices.
- The EtherNet/IP Unit supports tag data links to enable sharing data between devices at Ethernet nodes and a message service for sending and receiving data when required.
- The EtherNet/IP Unit supports the same FINS/UDP and FINS/TCP functionality as Ethernet Units.



CJ1W-EIP21

EtherNet/IP™

## Features

- Large-capacity tag data links are easily enabled by simply setting connections, with no programming required.
- Tag data links can be used to exchange data with up to 256 nodes over up to 256 connections.
- Up to 256 connections can be set per Unit with up to 722 words of data per connection, for a total of up to 184,832 words of link data. (There is no limit to the data link capacity for the overall network.)
- Data concurrency is maintained within each connection (for up to 722 words).
- Tag data link settings can be changed for individual Units even while tag data links are being used on a network.
- Errors can be diagnosed using the Network Configurator, and system errors can be monitored with a wide array of status flags.

## System Configuration

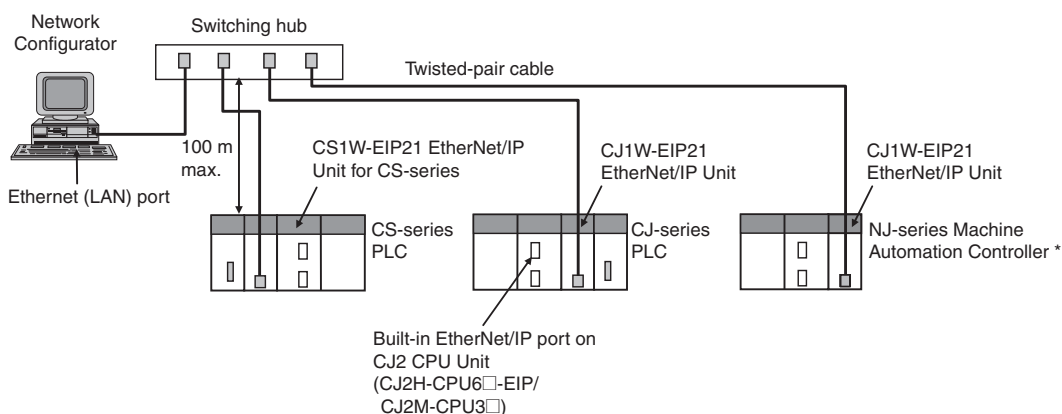

\* EtherNet/IP Unit with unit version 2.1 or later is required to connect C1JW-EIP21 to NJ-series CPU Unit. Use CPU Unit with version 1.01 or later and Sysmac Studio with version 1.02 or later.

## Ordering Information

### International Standards

- The standards are abbreviated as follows: U: UL, U1: UL (Class I Division 2 Products for Hazardous Locations), C: CSA, UC: cULus, UC1: cULus (Class I Division 2 Products for Hazardous Locations), CU: cUL, N: NK, L: Lloyd, and CE: EC Directives.
- Contact your OMRON representative for further details and applicable conditions for these standards.



### EtherNet/IP Unit

Unit type	Product name	Specifications			No. of unit numbers allocated	Current consumption (A)		Model	Standards
		Communications cable	Communications functions	Units per CPU Unit		5 V system	24 V system		
CJ1 CPU Bus Unit	 EtherNet/IP Unit	Shielded twisted-pair (STP) cable Categories: 100 Ω at 5, 5e	Tag Data Link Functions, Message Communications Functions	8 max. *1	1	0.41	–	CJ1W-EIP21 *2	UC1, N, L, CE

\*1. Up to four EtherNet/IP Units can be connected to a NJ CPU Unit. Up to seven EtherNet/IP Units can be connected to a CJ2H-CPU6□-EIP. Up to two EtherNet/IP Units can be connected to a CJ2M CPU Unit.

\*2. EtherNet/IP Unit with unit version 2.1 or later is required to connect CJ1W-EIP21 to NJ-series CPU Unit. Use CPU Unit with version 1.01 or later and Sysmac Studio with version 1.02 or later.

### Industrial Switching Hubs

Product name	Appearance	Specifications			Accessories	Current consumption (A)	Model	Standards
		Functions	No. of ports	Failure detection				
Industrial Switching Hubs		Quality of Service (QoS): EtherNet/IP control data priority Failure detection: Broadcast storm and LSI error detection 10/100BASE-TX, Auto-Negotiation	3	No	• Power supply connector	0.22	W4S1-03B	UC, CE
	5		No	0.22		W4S1-05B		
			5	Yes	• Power supply connector • Connector for informing error	0.22	W4S1-05C	CE

### Recommended Network Devices

The following table shows the devices recommended for use with the EtherNet/IP.

Part	Manufacturer	Model number	Inquires
Switching Hub	Phoenix Contact	FL SWITCH SFN 8TX (8 ports)	Phoenix Contact USA Customer Service
	Contec USA, Inc.	SH8008(FIT)H (8 ports)	CONTEC USA Inc.
	Cisco Systems, Inc.	WS-C2955T-12 (12 ports)	Cisco Systems, Inc. Main Corporate HQ
Twisted-pair cable	<b>100BASE-TX</b>		
	Fujikura	F-LINK-E 0.5mm × 4P	Fujikura America, Inc.
	EtherNet/IP compliant cable		–
Connectors (Modular plug)	<b>STP Plug</b>		
	Panduit Corporation	MPS588	Panduit Corporation US Headquarters
Boots	Tsuko Company	MK boot (IV) LB	Tsuko Company Japan Headquarters

**Note:** 1. Always use a switching hub when using tag data links in the network.

2. If a repeater hub is used for EtherNet/IP tag data links (cyclic communications), the network's communications load will increase, data collisions will occur frequently, and stable communications will be impossible.

## Mountable Racks

Model	NJ system		CJ1 system		CP1H system	NSJ system	
	CPU Rack	Expansion Rack	CPU Rack	Expansion Backplane	CP1H PLC	NSJ Controller	Expansion Backplane
CJ1W-EIP21	4 Units (per CPU Unit) *1		8 Units (per CPU Unit) *2		2 Units *3	Not supported	8 Units

\*1. EtherNet/IP Unit with unit version 2.1 or later is required to connect CJ1W-EIP21 to NJ-series CPU Unit. Use CPU Unit with version 1.01 or later and Sysmac Studio with version 1.02 or later.

\*2. Up to seven EtherNet/IP Units can be connected to a CJ2H-CPU6□-EIP. Up to two EtherNet/IP Units can be connected to a CJ2M CPU Unit.

\*3. A CP1W-EXT01 CJ Unit Adaptor is required.

Sysmac is a trademark or registered trademark of OMRON Corporation in Japan and other countries for OMRON factory automation products.

Windows are either registered trademarks or trademarks of Microsoft Corporation in the United States and/or other countries.

EtherNet/IP™ and DeviceNet™ are trademarks of the ODVA.

Other company names and product names in this document are the trademarks or registered trademarks of their respective companies.

## EtherNet/IP Units Specifications

Item		Specifications
<b>Model number</b>		CJ1W-EIP21
<b>Type</b>		100Base-TX *1
<b>Applicable PLCs</b>		NJ-series, CJ (CJ1, CJ2) series, CP1H, and NSJ series PLCs.
<b>Unit classification</b>		CJ-series CPU Bus Unit
<b>Mounting location</b>		CPU Rack or Expansion Rack
<b>Number of Units that can be mounted</b>		NJ-series System : 4 max. (including Expansion Racks) CJ series System and NSJ series System: 8 max. (including Expansion Racks) *2 CP1H System: 2 max.
<b>CPU Unit words used</b>	<b>Allocated CIO Area words (CPU Bus Unit words)</b>	25 words/Unit (one unit number's words) These words contain control bits and flags, the target node PLC's operating and error information, Unit status, communications status, registered/normal target node information, and FINS/TCP connection status.
	<b>Allocated DM Area words (CPU Bus Unit words)</b>	100 words/Unit (one unit number's words) These words contain the IP address display/setting area.
	<b>User-set area</b>	Any usable data area words Target node PLC's operating and error information, and registered/normal target node information
	<b>CPU Bus Unit System Setup</b>	Not used.
<b>Non-volatile memory within EtherNet/IP Unit (See note.)</b>		The following settings are stored in the EtherNet/IP Unit's non-volatile memory. <b>Note:</b> Unlike the regular Ethernet Units, the CPU Bus Unit Setup Area in the CPU Unit is not used for these settings. 1. Unit Setup (communications settings for the EtherNet/IP Unit, such as the IP address, DNS server settings, host name, baud rate, FINS/UDP settings, and FINS/TCP settings) 2. Tag data link settings (device parameters)
<b>Transfer specifications</b>	<b>Media access method</b>	CSMA/CD
	<b>Modulation method</b>	Baseband
	<b>Transmission paths</b>	Star form
	<b>Baud rate</b>	100 Mbit/s (100Base-TX)
	<b>Transmission media</b>	Shielded twisted-pair (STP) cable Categories: 100 Ω at 5, 5e
	<b>Transmission distance</b>	100 m (distance between hub and node)
	<b>Number of cascade connections</b>	There is no limitation when a switching hub is used.
<b>Current consumption (Unit)</b>		410 mA max. at 5 V DC
<b>Weight</b>		94 g max.
<b>Dimensions</b>		31 × 90 × 65 mm (W × H × D)
<b>Other general specifications</b>		Other specifications conform to the general specifications of the CJ-series.

\*1. If tag data links are being used, use 100Base-TX. Otherwise, 10Base-T can be used, but this is not recommended.

\*2. Up to seven EtherNet/IP Units can be connected to a CJ2H-CPU6□-EIP. Up to two EtherNet/IP Units can be connected to a CJ2M CPU Unit.

# Communications Specifications

Item		Specifications		
		NJ	CJ2	CJ1
CIP service	Tag data links (Cyclic communications)	Number of connections	256	
		Packet interval (refresh cycle)	0.5 to 10,000 ms (in 0.5-ms units) Can be set independently for each connection. (Data is refreshed over the network at the preset interval and does not depend on the number of nodes.)	
		Maximum allowed communications bandwidth per Unit	6,000 to 12,000 pps *1 *2	
		Number of tag sets	256	
		Tag types	CIO Area, DM Area, EM Area, Holding Area, Work Area, and network symbols *3	
		Number of tags per connection (= 1 tag set)	8 (7 tags when the tag set contains the controller status)	
		Maximum link data size per node	184,832 words	
		Maximum data size per connection *4	504 bytes (252 words) or 1444 bytes (722 words) *3 Data synchronicity is maintained within each connection.	
		Number of registrable tag sets	256 (1 connection = 1 tag set)	
		Maximum size of 1 tag set	722 words (The controller status uses 1 word when the tag set contains the PLC status.)	
		Maximum number of tags that can be refreshed per CPU Unit cycle *5	Output/Transmission (CPU to EtherNet/IP): 256 Input/Reception (EtherNet/IP to CPU): 256	Output/Transmission (CPU to EtherNet/IP): 19 Input/Reception (EtherNet/IP to CPU): 20 *6
		Data that can be refreshed per CPU Unit cycle *5	Output/Transmission (CPU to EtherNet/IP): 6,432 words Input/Reception (EtherNet/IP to CPU): 6,432 words	Output/Transmission (CPU to EtherNet/IP): 7,405 words Input/Reception (EtherNet/IP to CPU): 7,405 words
		Changing tag data link parameters during operation	Supported *7	
	Multicast packet filter function *8	Supported		
	Explicit messaging *9	Class 3 (connected)	Number of connections: 128	
UCMM (unconnected)		Number of clients that can communicate at one time: 32 max. Number of servers that can communicate at one time: 32 max.		
CIP routing *10		Supported CJ1W-EIP21, CS1W-EIP21, NJ501-□□□□, NJ301-□□□□, CJ2H-CPU□□-EIP, CJ2M-CPU3□		
FINS service	FINS/UDP	Not supported	Supported	
	FINS/TCP	Not supported	16 connections max.	
EtherNet/IP conformance test		Conforms to A8		
Ethernet interface		10BASE-T or 100BASE-TX Auto Negotiation or fixed settings		

- \*1. In this case, pps means "packets per second" and indicates the number of packets that can be processed in one second.
- \*2. When using the EtherNet/IP Unit with version 3.0 or later. When using the EtherNet/IP Unit with version 2.1 or earlier, the maximum allowed communications bandwidth per Unit is 6,000 pps. When using the EtherNet/IP Unit with version 3.0 or later, the Network Configurator with version 3.57 or higher is required.
- \*3. Network symbols can be used only by the NJ501-□□□□, NJ301-□□□□, CJ2H-CPU□□-EIP and CJ2M-CPU3□.
- \*4. To use 505 to 1,444 bytes as the data size, the system must support the Large Forward Open standard (an optional CIP specification). The CS/CJ-series Units support this standard, but before connecting to nodes of other companies, confirm that those devices also support it.
- \*5. If the maximum data size is exceeded, the data refreshing with the CPU Unit will extend over two or more cycles.
- \*6. If status layout is selected in the user settings, the maximum number of tags that can be received is 19 tags.
- \*7. If parameters are changed in the EtherNet/IP Unit, however, the EtherNet/IP Unit will be restarted. When other nodes are communicating with the affected node, the communications will temporarily time out and automatically recover later.
- \*8. Because the EtherNet/IP Unit is equipped with an IGMP client, unnecessary multicast packets can be filtered by using a switching hub that supports IGMP snooping.
- \*9. The EtherNet/IP Unit uses the TCP/UDP port numbers shown in the following table.

Service	Protocol		Port number		Remarks	
	CJ1/CJ2	NJ	CJ1/CJ2	NJ	CJ1/CJ2	NJ
Used by system	---	UDP	---	2223, 2224	Fixed value	
Tag data links	UDP		2222			
Class3, UCMM	TCP/UDP		44818			
DNS	UDP		53			
BOOTP client	---	UDP	---	68	Port numbers in the Unit Setup can be changed with the CX-Programmer.	Port numbers in the Unit Setup can be changed with the Sysmac Studio.
FINS/UDP service	UDP	---	9600	---		
FINS/TCP service	TCP	---	9600	---		
FTP	TCP		20, 21	21		
SNTP	UDP		123			
SNMP	UDP		161			
SNMP trap	UDP		162			

\*10. When NJ-Series CPU Units is described, Supported only by the EtherNet/IP Units with unit version 2.1 or later and NJ-Series CPU Units with unit version 1.01 or later.

## Unit Versions and Software Versions

The following versions of the Sysmac Studio, CX-Programmer and Network Configurator are required to set EtherNet/IP Units.

Yes:Supported, ---:Not supported

CJ1W-EIP21	Sysmac Studio *1		CX-Programmer *2			Network Configurator for EtherNet/IP	
	Ver.1.01 or lower	Ver.1.02 or higher	Ver.7.1 or lower	Ver.8.0 or higher	Ver.8.02 or higher	Ver.3.40 or lower	Ver.3.50 or higher
Ver.1.0	---	---	---	Yes *3	Yes	Yes	Yes
Ver.2.0	---	---	---	Yes	Yes	Yes	Yes
Ver.2.1	---	Yes	---	Yes	Yes	---	Yes
Ver.3.0 *4	---	Yes	---	Yes	Yes	---	Yes

\*1. Available only when connecting with NJ-series CPU Units.

\*2. Available only when connecting with CJ1/CJ2-series CPU Units.

\*3. The most recent version of the common module for CX-One version 3.□□ must be installed.

\*4. Using the Sysmac Studio auto-update (November 2014 or later).

## Network Configurator Requirements

The Network Configurator Ver. 3.0 or higher is a software package designed for building, setting, and controlling a multi-vendor EtherNet/IP Network using OMRON's EtherNet/IP. It is included in CX-One version 3.0. The Network Configurator provides the following functions for building, setting, and controlling EtherNet/IP.

Item	Specification									
Operating environment	Refer to the <i>CX-One Setup Manual</i> (Cat. No. W463). CXONE-AL□□C-V□/CXONE-AL□□D-V□									
Network connection method	<table border="1"> <thead> <tr> <th>CS1/CJ1</th> <th>CJ2</th> <th>NJ</th> </tr> </thead> <tbody> <tr> <td>CPU Unit's Peripheral or RS-232C port</td> <td>CPU Unit's USB or RS-232C port</td> <td>CPU Unit's USB port</td> </tr> <tr> <td>EtherNet/IP Unit's Ethernet port</td> <td>CPU Unit's Ethernet port EtherNet/IP Unit's Ethernet port</td> <td></td> </tr> </tbody> </table>	CS1/CJ1	CJ2	NJ	CPU Unit's Peripheral or RS-232C port	CPU Unit's USB or RS-232C port	CPU Unit's USB port	EtherNet/IP Unit's Ethernet port	CPU Unit's Ethernet port EtherNet/IP Unit's Ethernet port	
	CS1/CJ1	CJ2	NJ							
CPU Unit's Peripheral or RS-232C port	CPU Unit's USB or RS-232C port	CPU Unit's USB port								
EtherNet/IP Unit's Ethernet port	CPU Unit's Ethernet port EtherNet/IP Unit's Ethernet port									
Location on Network	A single node address is used (only when directly connected to EtherNet/IP).									
Number of Units that can be connected to Network	A single Network Configurator per Network (More than one Configurator cannot be used in the same system.)									
Main functions	<ul style="list-style-type: none"> <li>The Network configuration can be created and edited regardless of whether the Network Configurator is online or offline.</li> <li>The Network configuration can be read from a file or the network.</li> </ul>									
	Configuration functions	The EDS files used by the Network Configurator can be installed and deleted.								
Supported file formats	Configurator network configuration files (*.ncf) Configuration files (*.ncf) created using the Network Configurator for EtherNet/IP (version 2) can be imported by selecting <b>External Data - Import</b> from the File Menu.									

## External Interface

### CJ1W-EIP21

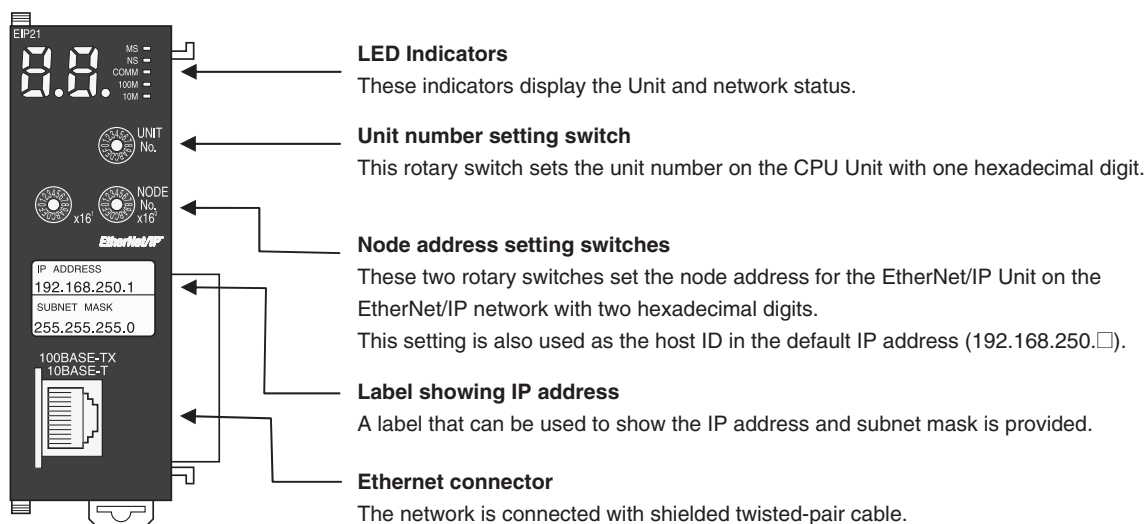

### Ethernet Connectors

The following standards and specifications apply to the connectors for the Ethernet twisted-pair cable.

- Electrical specifications: Conforming to IEEE802.3 standards.
- Connector structure: RJ45 8-pin Modular Connector (conforming to ISO 8877)

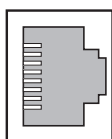

Connector pin	Signal name	Abbr.	Signal direction
1	Transmission data +	TD+	Output
2	Transmission data -	TD-	Output
3	Reception data +	RD+	Input
4	Not used.	-	-
5	Not used.	-	-
6	Reception data -	RD-	Input
7	Not used.	-	-
8	Not used.	-	-
Hood	Frame ground	FG	-

# Functional Comparison of EtherNet/IP Functionality

OK:Supported, ---:Not supported

Item	EtherNet/IP Unit (built-in port on CJ2 CPU Unit)			Built-in EtherNet/IP port on NJ-series CPU Unit	CJ-series Ethernet Unit
	Unit version 1.0	Unit version 2.0	Unit version 2.1 Unit version 3.0		
Tag data link communications service	OK	OK	OK	OK	---
CIP message communications service	OK	OK	OK	OK	---
Socket service	---	---	---	OK	OK
File transfer (FTP)	---	OK	OK	OK	OK
Mail send/receive	---	---	---	---	OK
Web functions	---	---	---	---	OK
Automatic adjustment of PLC/Controller's internal clock	---	OK	OK	OK	OK
Error history	OK	OK	OK	OK *1	OK
Response to PING command	OK	OK	OK	OK	OK
SNMP/SNMP trap	---	OK	OK	OK	---
CIDR function for IP addresses	---	OK	OK	OK	---
Online connection via EtherNet/IP using CX-One/Sysmac Studio	---	OK	OK	---	---
Online connection via EtherNet/IP using Network Configurator	OK	OK	OK	OK	---
Mounting in a Controller with an NJseries CPU Unit	---	---	OK *2	---	---

\*1. This is equivalent to the event log of the built-in EtherNet/IP port of an NJ-series Controller.

\*2. You cannot use the following functions if you connect to the CPU Unit through an EtherNet/IP Unit.

- Going online with a CPU Unit from the Sysmac Studio. (However, you can go online from the Network Configurator.)
- Troubleshooting from an NS-series PT

## Dimensions

(Unit: mm)

### CJ1W-EIP21

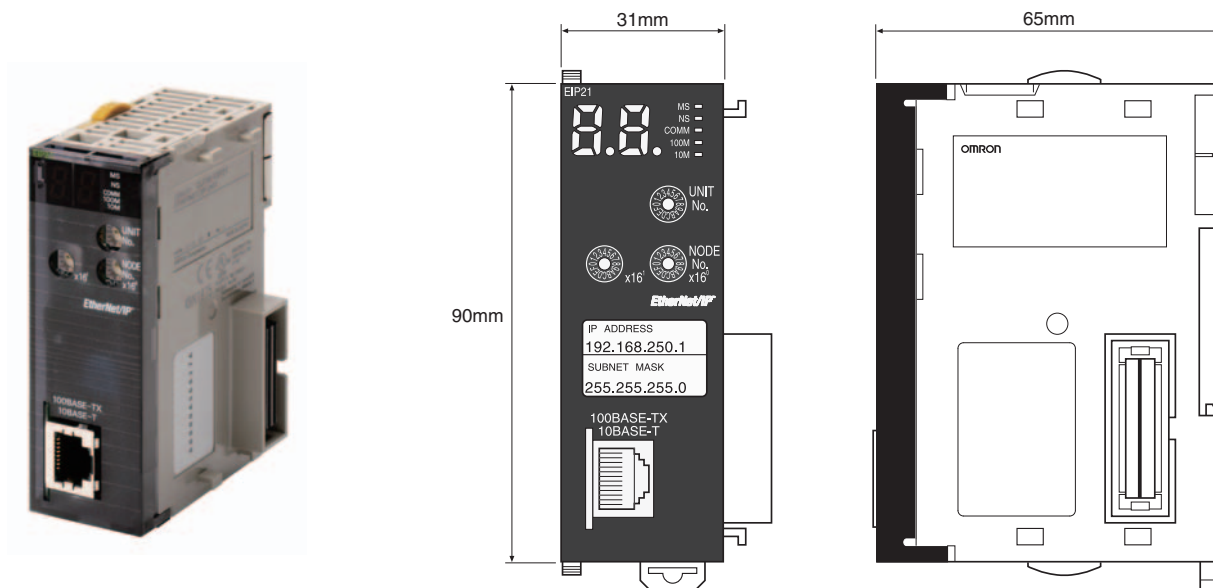

## Related Manuals

Manual number	Model	Name	Contents
W465	CS1W-EIP21 CJ1W-EIP21 CJ2H-CPU□□-EIP CJ2M-CPU3□	EtherNet/IP Units Operation Manual	Provides information on operating and installing EtherNet/IP Units, including details on basic settings, tag data links, and FINS communications. Refer to the <i>Communications Commands Reference Manual</i> (W342) for details on FINS commands that can be sent to CS-series and CJ-series CPU Units when using the FINS communications service. Refer to the <i>Ethernet Units Operation Manual Construction of Applications</i> (W421) for details on constructing host applications that use FINS communications.
W495	CJ1W-EIP21	CJ-series EtherNet/IP Units Operation Manual for NJ-series CPU Unit	Information on using an EtherNet/IP Unit that is connected to an NJ-series CPU Unit is provided. Information is provided on the basic setup, tag data links, and other features. Use this manual together with the NJ-series CPU Unit Hardware User's Manual (Cat. No. W500) and NJ-series CPU Unit Software User's Manual (Cat. No. W501).
W421	CS1W-ETN21 CJ1W-ETN21	Ethernet Units Operation Manual Construction of Applications	Provides information on constructing host applications for 100Base-TX Ethernet Units, including functions for sending/receiving mail, socket service, automatic clock adjustment, FTP server functions, and FINS communications.
W342	CS1G/H-CPU□□H CS1G/H-CPU-□□V1 CS1W-SCU21 CS1W-SCB21/41 CJ1G/H-CPU□□H CJ1G-CPU□□ CJ1W-SCU41	Communications Commands Reference Manual	Describes the C-series (Host Link) and FINS communications commands used when sending communications commands to CS-series and CJ-series CPU Units.
W463	CXONE-AL□□C/D-V□	CX-One Setup Manual	Describes the setup procedures for the CX-One. Information is also provided on the operating environment for the CX-One.

## Terms and Conditions Agreement

### Read and understand this catalog.

Please read and understand this catalog before purchasing the products. Please consult your OMRON representative if you have any questions or comments.

### Warranties.

(a) Exclusive Warranty. Omron's exclusive warranty is that the Products will be free from defects in materials and workmanship for a period of twelve months from the date of sale by Omron (or such other period expressed in writing by Omron). Omron disclaims all other warranties, express or implied.

(b) Limitations. OMRON MAKES NO WARRANTY OR REPRESENTATION, EXPRESS OR IMPLIED, ABOUT NON-INFRINGEMENT, MERCHANTABILITY OR FITNESS FOR A PARTICULAR PURPOSE OF THE PRODUCTS. BUYER ACKNOWLEDGES THAT IT ALONE HAS DETERMINED THAT THE PRODUCTS WILL SUITABLY MEET THE REQUIREMENTS OF THEIR INTENDED USE.

Omron further disclaims all warranties and responsibility of any type for claims or expenses based on infringement by the Products or otherwise of any intellectual property right. (c) Buyer Remedy. Omron's sole obligation hereunder shall be, at Omron's election, to (i) replace (in the form originally shipped with Buyer responsible for labor charges for removal or replacement thereof) the non-complying Product, (ii) repair the non-complying Product, or (iii) repay or credit Buyer an amount equal to the purchase price of the non-complying Product; provided that in no event shall Omron be responsible for warranty, repair, indemnity or any other claims or expenses regarding the Products unless Omron's analysis confirms that the Products were properly handled, stored, installed and maintained and not subject to contamination, abuse, misuse or inappropriate modification. Return of any Products by Buyer must be approved in writing by Omron before shipment. Omron Companies shall not be liable for the suitability or unsuitability or the results from the use of Products in combination with any electrical or electronic components, circuits, system assemblies or any other materials or substances or environments. Any advice, recommendations or information given orally or in writing, are not to be construed as an amendment or addition to the above warranty.

See <http://www.omron.com/global/> or contact your Omron representative for published information.

### Limitation on Liability; Etc.

OMRON COMPANIES SHALL NOT BE LIABLE FOR SPECIAL, INDIRECT, INCIDENTAL, OR CONSEQUENTIAL DAMAGES, LOSS OF PROFITS OR PRODUCTION OR COMMERCIAL LOSS IN ANY WAY CONNECTED WITH THE PRODUCTS, WHETHER SUCH CLAIM IS BASED IN CONTRACT, WARRANTY, NEGLIGENCE OR STRICT LIABILITY.

Further, in no event shall liability of Omron Companies exceed the individual price of the Product on which liability is asserted.

### Suitability of Use.

Omron Companies shall not be responsible for conformity with any standards, codes or regulations which apply to the combination of the Product in the Buyer's application or use of the Product. At Buyer's request, Omron will provide applicable third party certification documents identifying ratings and limitations of use which apply to the Product. This information by itself is not sufficient for a complete determination of the suitability of the Product in combination with the end product, machine, system, or other application or use. Buyer shall be solely responsible for determining appropriateness of the particular Product with respect to Buyer's application, product or system. Buyer shall take application responsibility in all cases.

NEVER USE THE PRODUCT FOR AN APPLICATION INVOLVING SERIOUS RISK TO LIFE OR PROPERTY OR IN LARGE QUANTITIES WITHOUT ENSURING THAT THE SYSTEM AS A WHOLE HAS BEEN DESIGNED TO ADDRESS THE RISKS, AND THAT THE OMRON PRODUCT(S) IS PROPERLY RATED AND INSTALLED FOR THE INTENDED USE WITHIN THE OVERALL EQUIPMENT OR SYSTEM.

### Programmable Products.

Omron Companies shall not be responsible for the user's programming of a programmable Product, or any consequence thereof.

### Performance Data.

Data presented in Omron Company websites, catalogs and other materials is provided as a guide for the user in determining suitability and does not constitute a warranty. It may represent the result of Omron's test conditions, and the user must correlate it to actual application requirements. Actual performance is subject to the Omron's Warranty and Limitations of Liability.

### Change in Specifications.

Product specifications and accessories may be changed at any time based on improvements and other reasons. It is our practice to change part numbers when published ratings or features are changed, or when significant construction changes are made. However, some specifications of the Product may be changed without any notice. When in doubt, special part numbers may be assigned to fix or establish key specifications for your application. Please consult with your Omron's representative at any time to confirm actual specifications of purchased Product.

### Errors and Omissions.

Information presented by Omron Companies has been checked and is believed to be accurate; however, no responsibility is assumed for clerical, typographical or proofreading errors or omissions.

2015.7

In the interest of product improvement, specifications are subject to change without notice.

**OMRON Corporation**  
Industrial Automation Company

<http://www.ia.omron.com/>

(c)Copyright OMRON Corporation 2015 All Right Reserved.