

Grounding-type panel mounted receptacle - Part no. 10712



- Swiss standard
- type 25
- with hinged lid
- 5 screw terminals
- receptacle cannot be combined with enclosure base part no. 10714, 10715 or 10716

Technical information

Ampere	16 A
Poles	5 p
Voltage	400V
Shutter	no
Connection technology	Screw terminals
Contact	standard
Protection type	IP 54

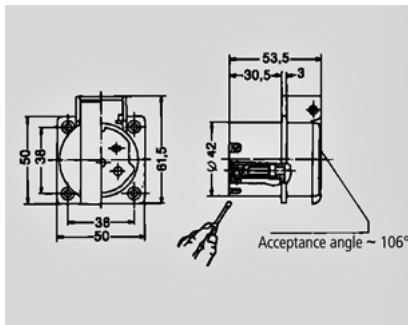
Drawing
1 MB 424

Dim. in mm