

**Wall mounted receptacle - Part no. 136A**

- screw terminals
- with SoftCONTACT
- internal fixing
- enclosure base can be turned 180°
- with 6 fixing points to accommodate special terminals
- products with pilot contact on request

## Technical information

Ampere	63 A
Poles	5 p
Voltage	400V
Earth position	6 h
Hertz	50-60 Hz
Connection technology	Screw terminals
Contact	standard
Protection type	IP 67

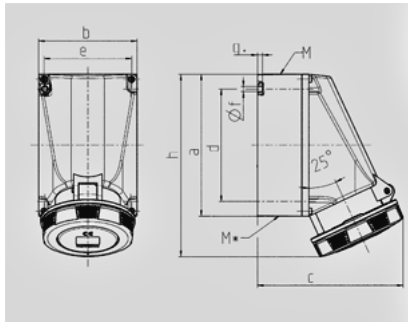

Drawing 1 MB 112	Amp. Poles	63		
		3	4	5
Dim. in mm	a	170	170	170
	b	118	118	118
	c	175	175	175
	d	134,5	134,5	134,5
	e	103	103	103
	f	6,1	6,1	6,1
	g	6	6	6
	h	219	219	219
	M	40	40	40
	M*	2x40 (blind) to be cut out		
Max. cable diam. (mm)		27	27	27
Terminal for cond. cross section (mm²) min.-max.		6	6	6
		-25	-25	-25