

Phase sequence test plug - Part no. 1414

- to VDE 0413, part 7, DIN-EN 61557-7



Technical information

Ampere	16 A
Poles	5 p
Voltage	400V
Earth position	6 h
Hertz	50-60 Hz
Connection technology	Screw terminals
Contact	standard
Protection type	IP 44

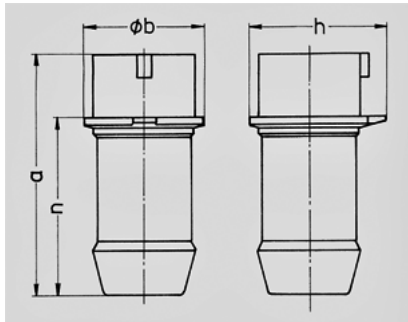

Drawing 2 MB 140 Dim. in mm	Amp. Poles	16		32		63	
		4	5	4	5	4	5
a		126	129	145	145	211	211
b		60	65	66	74	100	100
h		62	69	71	80	100	100
n		90	93	99	99	145	145