

Wall mounted receptacle - Part no. 142

- screw terminals
- products with pilot contact on request

Technical information

Ampere	125 A
Poles	5 p
Voltage	230V
Earth position	9 h
Hertz	50-60 Hz
Connection technology	Screw terminals
Contact	standard
Protection type	IP 67

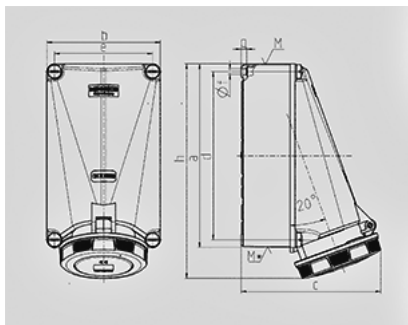

Drawing 1 MB 162	Amp. Poles	125	
		4	5
Dim. in mm	a	264	264
	b	163	163
	c	200	200
	d	240	240
	e	140	140
	f	8,1	8,1
	g	8	8
	h	306	306
	M	50	50
	M*	50	50
Max. cable diam. (mm)		38	38
Terminal for cond. cross section (mm²) min.-max.		25 25	—35 —35