

Connector PowerTOP® - Part no. 3896

- screw terminals
- with highly heat resistant contact carrier
- cable gland and external cable grip

Technical information	
Ampere	32 A
Poles	4 p
Voltage	110V
Earth position	4 h
Hertz	50-60 Hz
Connection technology	Screw terminals
Contact	nickel plated contacts, highly heat resistant contact carrier
Protection type	IP 67

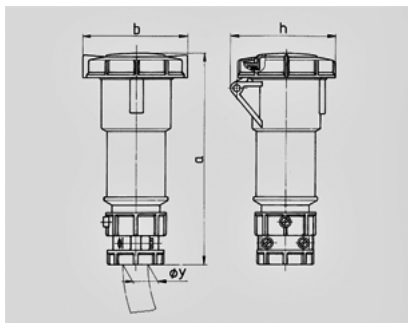

Drawing 3 MB 48/3	Amp. Poles	16			32		
		3	4	5	3	4	5
Dim. in mm	a	171	182	194	217	217	229
	b	78	85	96	103	103	110
	h	79	88	95	99	99	105
	y	19	19	22	24,5	24,5	28,5
Terminal for cond. cross		1	1	1	2,5	2,5	2,5
section (mm²) min.-max.		—2,5	—2,5	—2,5	—6	—6	—6