

Connector PowerTOP® - Part no. 3974

- screw terminals
- with highly heat resistant contact carrier
- cable gland and external cable grip

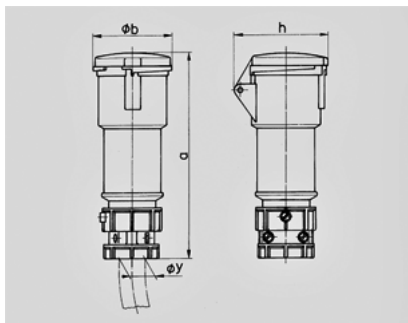

Technical information	
Ampere	32 A
Poles	5 p
Voltage	110V
Earth position	4 h
Hertz	50-60 Hz
Connection technology	Screw terminals
Contact	highly heat resistant contact carrier
Protection type	IP 44



Drawing 3 MB 51/3	Amp. Poles	16			32		
		3	4	5	3	4	5
Dim. in mm	a	165	180	190	214	214	223
	b	60	68	76	82	82	89
	h	76	84	90	92	92	99
	y	19	19	22	24,5	24,5	28,5
Terminal for cond. cross		1	1	1	2,5	2,5	2,5
section (mm ²) min.-max.		—2,5	—2,5	—2,5	—6	—6	—6