

**Cepex wall mounted receptacle - Part no. 4138**

- screw terminals
- with labelling field

**Technical information**

Ampere	32 A
Poles	4 p
Voltage	400V
Earth position	6 h
Hertz	50-60 Hz
Protection type	IP 44

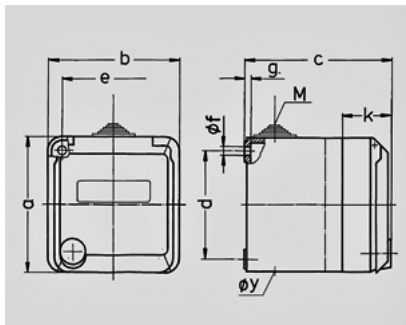

Drawing 1 MB 317	Amp. Poles	16			32		
		3	4	5	3	4	5
Dim. in mm	a	93	93	93	93	93	93
	b	90	90	90	90	90	90
	c	88	88	88	100	100	100
	d	75	75	75	75	75	75
	e	73	73	73	73	73	73
	f	5,5	5,5	5,5	5,5	5,5	5,5
	g	4,2	4,2	4,2	4,2	4,2	4,2
	k	34	34	34	34	34	34
	y	25,5	25,5	25,5	25,5	25,5	25,5
	M	25x1,5	25x1,5	25x1,5	25x1,5	25x1,5	25x1,5
Terminal for cond. cross section (mm <sup>2</sup> ) min.-max.		1,5	1,5	1,5	2,5	2,5	2,5
		-4	-4	-4	-6	-6	-6