

Wall mounted receptacle - Part no. 5925A

- screw terminals
- SoftCONTACT
- switched
- mechanical DUO-interlock
- receptacles can be padlocked

Technical information

Ampere	63 A
Poles	3 p
Voltage	110V
Earth position	4 h
Hertz	50-60 Hz
Connection technology	Screw terminals
Contact	standard
Protection type	IP 67

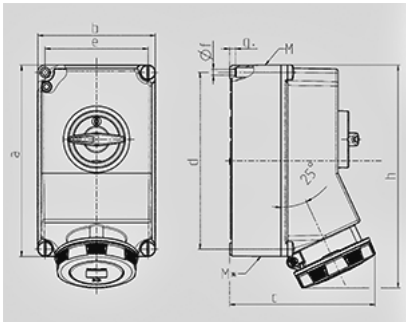

Drawing 1 MB 180	Amp. Poles	63		
		3	4	5
Dim. in mm	a	260	260	260
	b	160	160	160
	c	198	198	198
	d	240	240	240
	e	140	140	140
	f	8,1	8,1	8,1
	g	8	8	8
	h	303	303	303
	M	40	40	40
	M*	2 x 40	2 x 40	2 x 40
Max. cable diam. (mm)		27	27	27
Terminal for cond. cross section (mm²) min.-max.		6	6	6
		-25	-25	-25