

Wall mounted receptacle - Part no. 599

- screw terminals
- internal fixing
- one cable entry at top and two blind entries (can be cut out) at bottom
- lower part of enclosure base can be turned 180°

Technical information

Ampere	32 A
Poles	3 p
Voltage	20-25, 40-50 V
Hertz	100-200 Hz
Earth position	4 h
Connection technology	Screw terminals
Contact	standard
Protection type	IP 44

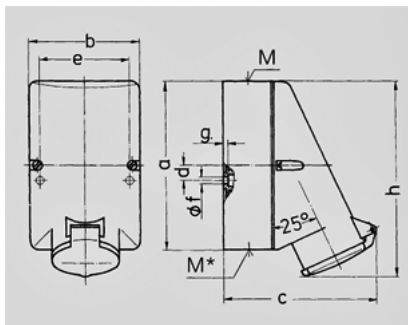

Drawing 1 MB 137	Amp. Poles	16		32	
		2	3	2	3
Dim. in mm	a	128	128	128	128
	b	84	84	84	84
	c	120	120	120	120
	d	11	11	11	11
	e	68	68	68	68
	f	5,3	5,3	5,3	5,3
	g	4	4	4	4
	h	146	146	146	146
	M	25	25	32	32
	M*	2x25 (blind) to be cut out		2x25 (blind) to be cut out	
	Max. cable diam. (mm)	18	18	25	25
	Terminal for cond. cross section (mm²) min.-max.	4	4	4	4
		-2x6	-10	-2x6	-10