

Plug - Part no. 662A

- screw terminals
- with cable gland

Technical information

Ampere	16 A
Poles	3 p
Voltage	20-25 V
Hertz	50-60 Hz
Earth position	0 h
Connection technology	Screw terminals
Contact	standard
Protection type	IP 44

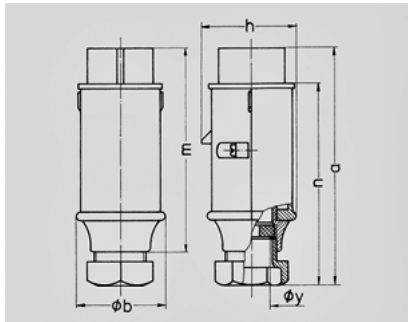

Drawing 2 MB 158	Amp. Poles	16		32	
		2	3	2	3
Dim. in mm	a	150	150	150	150
	b	55	55	55	55
	h	58	58	58	58
	m	128	128	128	128
	n	130	130	130	130
	y	24,7	24,7	24,7	24,7
Terminal for cond. cross section (mm²) min.-max.		4	4	4	4
		-10	-10	-10	-10