

Wall mounted receptacle - Part no. 7060

- screw terminals
- TorsionSpringCONTACT
- switched
- mechanical DUO-interlock
- upon request with provision for an additional padlock

Technical information

Ampere	125 A
Poles	3 p
Voltage	110V
Earth position	4 h
Hertz	50-60 Hz
Connection technology	Screw terminals
Contact	standard
Protection type	IP 67

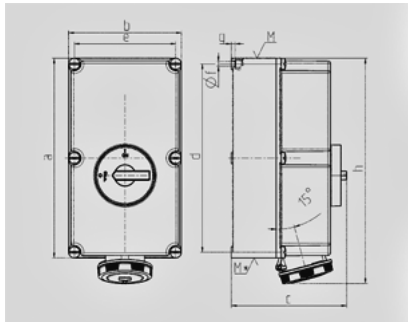

Drawing 1 MB 177	Amp. Poles	125		
		3	4	5
Dim. in mm	a	460	460	460
	b	260	260	260
	c	283	283	283
	d	434	434	434
	e	234	234	234
	f	11	11	11
	g.	9	9	9
	h	519	519	519
	M	63	63	63
	M*	2x63	2x63	2x63
Max. cable diam. (mm)		44	44	44
Terminal for cond. cross section (mm²) min.-max.		25 —70	25 —70	25 —70