

Plug - Part no. 75091

- screw terminals
- with cable gland
- seawater resistant products are available on request

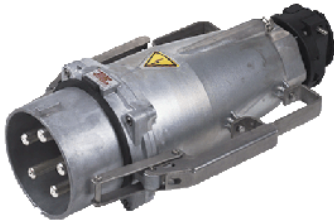

Technical information

Ampere	250 A
Poles	5 p
Voltage	400V
Earth position	6 h
Hertz	50-60 Hz
Connection technology	Screw terminals
Contact	standard
Protection type	IP 67

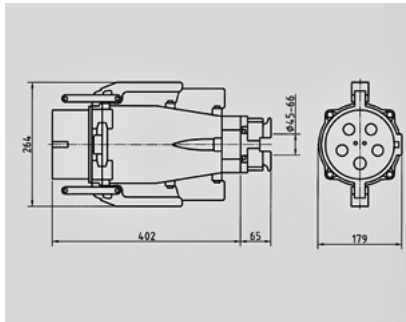
Drawing
2 MB 198/1

Dim. in mm