

Panel mounted receptacle - Part no. 7534

- screw terminals
- for horizontal installation
- switched
- mechanical DUO-interlock
- receptacles can be padlocked

Technical information

Ampere	32 A
Poles	4 p
Voltage	400V
Earth position	6 h
Hertz	50-60 Hz
Connection technology	Screw terminals
Contact	standard
Protection type	IP 67

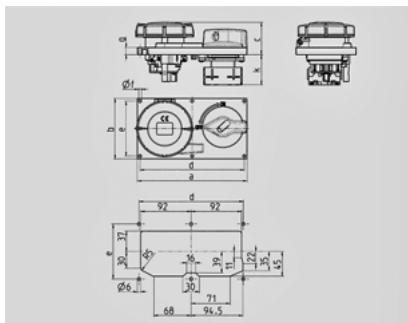

Drawing 5 MB 57	Amp. Poles	16			32		
		3	4	5	3	4	5
Dim. in mm	a	200	200	200	200	200	200
	b	110	110	110	110	110	110
	c	47	50	51	59	59	60
	d	190	190	190	190	190	190
	e	100	100	100	100	100	100
	f	5	5	5	5	5	5
	g	13	13	13	13	13	13
	k max.	56	56	56	56	56	56