

Panel mounted inlet - Part no. 824

- screw terminals
- highly heat resistant contact carrier
- nickel plated contacts
- a retaining nose to hold the hinged lid of the connector must be provided by the customer in order to ensure satisfactory locking

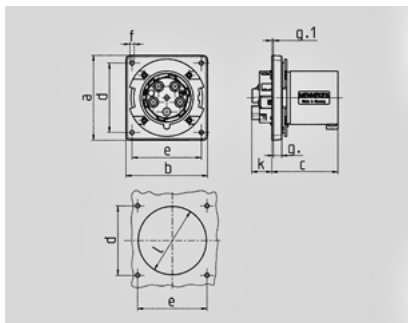

Technical information	
Ampere	63 A
Poles	4 p
Voltage	500V
Earth position	7 h
Hertz	50-60 Hz
Connection technology	Screw terminals
Contact	nickel plated contacts, highly heat resistant contact carrier
Protection type	IP 44



Drawing 2 MB 155	Amp. Poles	63		
		3	4	5
Dim. in mm	a	110	110	110
	b	106	106	106
	c	86	86	86
	d	90	90	90
	e	90	90	90
	f	5,5	5,5	5,5
	g.	12	12	12
	g.1	2	2	2
	k	28	28	28
	l	88,5	88,5	88,5
Terminal for cond. cross section (mm ²) min.-max.		6	6	6
		-16	-16	-16