

Panel mounted inlet RAPIDO® - Part no. 935

- screw terminals
- for wall aperture 70 mm Ø
- central fixing

Technical information

Ampere	32 A
Poles	3 p
Voltage	110V
Earth position	4 h
Hertz	50-60 Hz
Connection technology	Screw terminals
Contact	standard
Protection type	IP 44

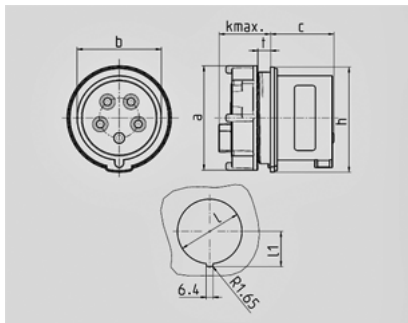

Drawing 2 MB 215	Amp. Poles	16		32		
		4	5	3	4	5
Dim. in mm	a	78	78	78	78	78
	b	50	56	58	58	64
	c	45	44	51	51	51
	k max.	33	33	33	33	33
	h	82	82	82	82	82
	l	70	70	70	70	70
	l1	37,75	37,75	37,75	37,75	37,75
	t	wall thicknesses 2-9mm		wall thicknesses 2-9mm		
	Terminal for cond. cross section (mm²) min.-max.	1,5	1,5	2,5	2,5	2,5
		-4	-4	-10	-10	-10