

CL1XY2-DT1D5S  
CC-Link/LT Remote I/O Module

User's Manual

Please read this manual thoroughly before starting to use the product and handle the product properly.



MODEL	CL1XY2-DT1D5S
MANUAL Number	JY997D03801G
Date	September 2008

●SAFETY PRECAUTIONS●  
(Read these precautions before using)

Please read this manual carefully and pay special attention to safety in order to handle this product properly. Also pay careful attention to safety and handle the module properly.

These precautions apply only to Mitsubishi equipment. Refer to the user's manual of the CPU module to use for a description of the PLC system safety precautions.

These ●SAFETY PRECAUTIONS● classify the safety precautions into two categories: "DANGER" and "CAUTION".

**DANGER** Procedures which may lead to a dangerous condition and cause death or serious injury if not carried out properly.

**CAUTION** Procedures which may lead to a dangerous condition and cause superficial to medium injury, or physical damage only, if not carried out properly.

Depending on circumstances, procedures indicated by **CAUTION** may also be linked to serious results. In any case, it is important to follow the directions for usage. Store this manual in a safe place so that you can take it out and read it whenever necessary. Always forward it to the end user.

**DESIGN PRECAUTIONS**

**DANGER**

- Configure an interlock circuit in a sequence program so that the system operates on the safety side using the communication status information in the event the data link falls into a communication problem. Otherwise, erroneous output and malfunction may result in accidents.
- Remote input and output can not be switched ON or OFF when a problem occurs in the remote I/O modules. Therefore build an external monitoring circuit that will monitor any input signals that could cause a serious accident.

**CAUTION**

- Do not have control cables and connection cables bundled with or placed near by the main circuit and/or power cables. Wire those cables at least 100mm(3.94 inch) away from the main circuit and/or power cables. It may cause malfunction due to noise interference.
- Use the module in the status in which any force is not applied on the module, flat cables dedicated to CC-Link/LT and flat cables for I/O. If a force is applied, wire breakage or failure may be caused.

**INSTALLATION PRECAUTIONS**

**CAUTION**

- Use the module in an environment that meets the general specifications contained in this manual. Using this module in an environment outside the range of the general specifications could result in electric shock, fire, erroneous operation, and damage to or deterioration of the product.
- Do not directly touch the module's conductive parts. Doing so could cause malfunction or trouble in the module.

**WIRING PRECAUTIONS**

**DANGER**

- Perform installation and wiring after disconnecting the power supply at all phases externally. If the power is not disconnected at all phases an electric shock or product damage may result.

**CAUTION**

- Perform correct wiring for the module according to the product's rated voltage and terminal arrangement. Connecting to a power supply different from rating or miss-wiring may cause fire, product failure or malfunction.
- Make sure foreign objects do not get inside the module, such as dirt and wire chips. It may cause fire, product failure or malfunction.
- Do not short-circuit the 24G and +24V terminals. It may result in fire, product failure or malfunction.
- Attach a warning label (hazard symbol 417-IEC-5036) concerning the electric shock to the location.

**STARTING AND MAINTENANCE PRECAUTIONS**

**DANGER**

- Do not touch the terminals when the power is ON. It may cause an electric shock or malfunction.
- Perform cleaning the module after turning OFF the all external power supply for sure. Failure to do so may cause failure or malfunction of the modules.

**CAUTION**

- Do not disassemble or modify the module. Doing so may cause failure, malfunction, injury, or fire.
- The module case is made of resin; do not drop it or subject it to strong shock. A module damage may result.
- Make sure to switch all phases of the external power supply OFF before installing or removing the module to/from the panel. Failure to do so may cause failure or malfunction of the modules.

**DISPOSAL PRECAUTIONS**

**DANGER**

- When disposing of this product, treat it as industrial waste.

**TRANSPORTATION AND MAINTENANCE PRECAUTIONS**

**CAUTION**

- During transportation avoid any impact as the module is a precision instrument. Doing so could cause trouble in the module.
- If it is necessary to check the operation of module after transportation, in case of any impact damage.

●Notification of CE marking●

This notification does not guarantee that an entire mechanical module produced in accordance with the contents of the notification comply with the following standards. Compliance to EMC standards of the entire mechanical module should be checked by the user / manufacturer.

**Standards with which this product complies**

Type : Programmable Controller (Open Type Equipment) Remote I/O module  
Models : Products manufactured:  
from November 1st, 2002 to April 30th, 2006 are compliant with EN61000-6-4 and EN61131-2:1994+A11:1996+A12:2000 after May 1st, 2006 are compliant with EN61131-2:2003

Electromagnetic Compatibility Standards (EMC)	Remark
EN61000-6-4:2001 Electromagnetic compatibility -Generic standards - Emission standard for Industrial environment	Compliance with all relevant aspects of the standard. (Radiated Emissions and Mains Terminal Voltage Emissions)
EN61131-2:1994/A11:1996/A12:2000 Programmable controllers -Equipment requirements and tests	Compliance with all relevant aspects of the standard. (RF Immunity, Fast transients, ESD and Damped oscillatory wave)
EN61131-2: 2003 Programmable controllers -Equipment requirements and tests	Compliance with all relevant aspects of the standard. (Radiated Emissions, Mains Terminal Voltage Emissions, RF immunity, Fast Transients, ESD, Surge, Voltage drops and interruptions, Conducted and Power magnetic fields)

For more details please contact the local Mitsubishi Electric sales site.

- Notes For compliance to EMC regulation.  
It is necessary to install the CL1 series module in a shielded metal control panel.

**1. Outline of Product**

This product is a cable type composite I/O module connected to CC-Link/LT. This product has one input point (24V DC) and one output point (transistor output).

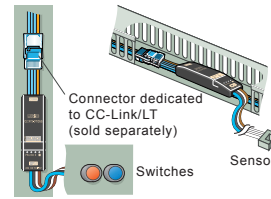

**2. Name and Setting of Each Part**

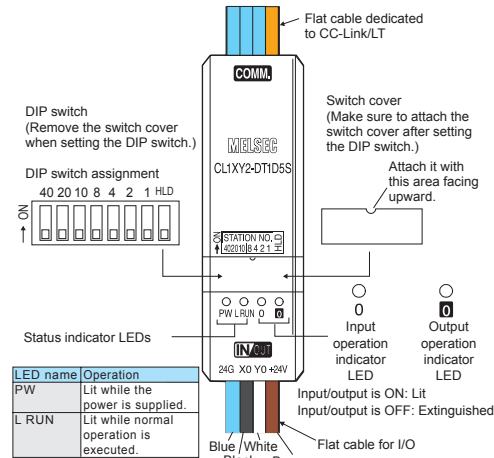

Name	Description
Status indicator LED	PW ON while the power is supplied. L RUN ON while normal operation is executed.
I/O operation indicator LED	ON while the input or output is ON. Extinguished while the input or output is OFF. X0 input operation indicator LED Y0 output operation indicator LED
Flat cable dedicated to CC-Link/LT	24G Connector for CC-Link/LT communication line/ DB module power supply DA +24V
Flat cable for I/O	Blue 24G Black X0 White Y0 Brown +24V
DIP switch	Set the 10's digit of the station No. using "STATION NO. 10", "STATION NO. 20" and "STATION NO. 40". Set the 1's digit of the station No. using "STATION NO. 1", "STATION NO. 2", "STATION NO. 4" and "STATION NO. 8". Factory default = All bits are OFF. Make sure to set the station No. in the range from 1 to 64. Example: When setting the station No. to "32", set the DIP switch as follows.

Station No.	10's digit	1's digit
40	ON	ON
20	ON	OFF
10	OFF	ON
8	OFF	OFF
4	OFF	ON
2	OFF	OFF
1	OFF	OFF

Name	Description
DIP switch	HLD Holds the output (when an error has occurred). ON: Holds the output. OFF: Clears the output.

**3. Cautions on Handling**

**3.1 Handling of flat cable for I/O**

The cable length from the module to a sensor shall be within 3m(9'10"). Measure the cable outside the module, and confirm that the driving voltage for the used sensor is assured.

• Input

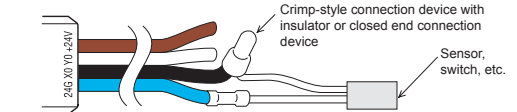

• Output

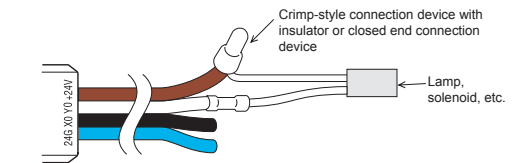

If the diameter of the I/O equipment connection cable is equivalent to the diameter of the flat cable for I/O of this module, connectors dedicated to CC-Link/LT can be used for connection.

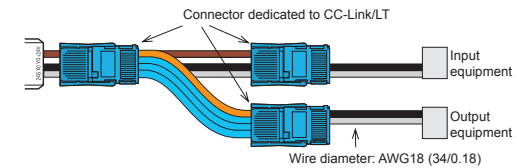

**3.2 Handling of cable**

Do not bend the cable within 30mm(1.18") from the module.

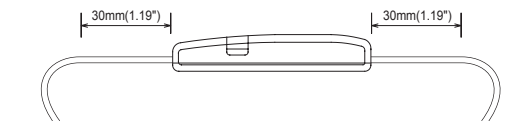

Use a crimp-style terminal in a status in which no force is applied on the cable.

**3.3 Mounting with the CL1-HLD (module holder)**

Refer to the figures below for details on mounting or removing the remote I/O module when used with the CL1-HLD.

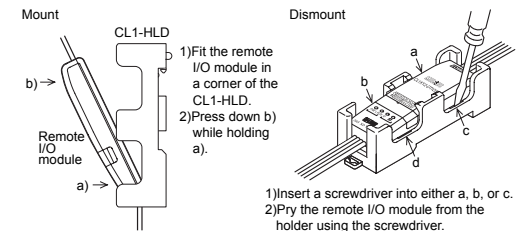

## 4. Wiring

### 4.1 External wiring

The input and output terminals of the CL1XY2-DT1D5S operate while using the power supplied from the interface.  
When connecting a sensor to the input terminal, use a sensor of the NPN open collector transistor type.  
The output wiring is fixed to the sink output.

### I/O wiring

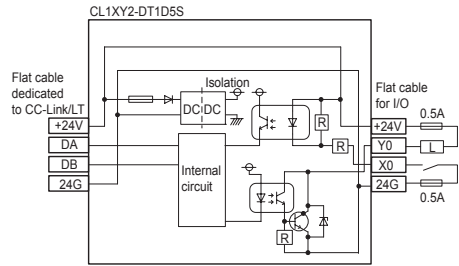

### 4.2 Connection to sensor

- When using a two-wire type sensor
- When using a three-wire type sensor

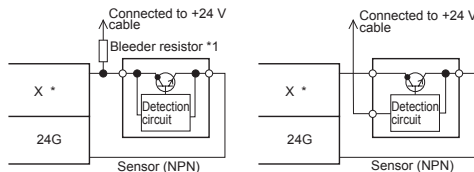

Replace \* in the figure with the used input No.

#### Notes:

##### \*1 Bleeder resistor

When connecting a two-wire type sensor or input equipment having parallel resistor, select a sensor or equipment whose leakage current is 1.7mA or less.  
If the leakage current is more than 1.7mA, connect a bleeder resistor obtained in the following calculation formula.

Circuit image

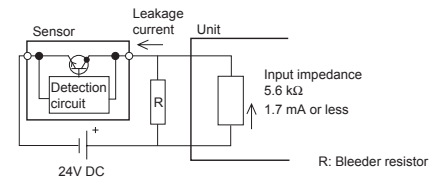

$$R(k\Omega) < 1.7(mA) / \text{Leakage current}(mA) - 1.7(mA) \times 5.6(k\Omega)$$

The power capacity W of the bleeder resistor R is as follows:

$$W = (\text{Input voltage})^2 / R$$

- Make sure that both the ON and OFF time of the input signal are 1.5ms or more.

## 5. Specifications

### 5.1 General specifications

Item	Specification			
<b>Ambient working temperature</b>	0 to 55°C (32 to 131°F)			
<b>Ambient storage temperature</b>	-25 to 75°C (-13 to 167°F)			
<b>Ambient operating humidity</b>	5 to 95%RH: Dew condensation shall not be considered.			
<b>Ambient storage humidity</b>	5 to 95%RH: Dew condensation shall not be considered.			
<b>Vibration resistance</b>	When intermittent vibration is present		Number of times of sweep  10 times in each of X, Y and Z directions (for 80 min)	
	Frequency	Acceleration		Half amplitude
	10 to 57Hz	-		0.075mm
	57 to 150Hz	9.8m/s <sup>2</sup>		-
	When continuous vibration is present			
	Frequency	Acceleration		Half amplitude
10 to 57Hz	-	0.035mm		
57 to 150Hz	4.9m/s <sup>2</sup>	-		
<b>Impact resistance</b>	147 m/s <sup>2</sup> , 3 times in each of X, Y and Z directions			
<b>Operating atmosphere</b>	Corrosive gas shall not be present.			
<b>Operating altitude</b>	2,000m(6561'8") or less(*1)			
<b>Installation place</b>	Inside control panel (*2)			
<b>Over-voltage category</b>	II or less(*3)			
<b>Degree of contamination</b>	2 or less (*4)			

#### Notes:

- \*1 The module cannot be used in an environment pressurized above the atmospheric pressure which can be generated around the altitude of 0 m. If the module is used in such an environment, it may fail.
- \*2 The module can be used in any environment even outside the control panel as far as the requirements of the ambient operating temperature, the ambient operating humidity, etc. are satisfied.
- \*3 This indicates the section of the power supply to which the equipment is assumed to be connected between the public electrical power distribution network and the machinery within premises. Category II applies to equipment for which electrical power is supplied from fixed facilities. The surge voltage withstand level for up to the rated voltage of 300V is 2500V.
- \*4 This index indicates the degree of conductive generating substances in the environment in which the module is used. The degree of contamination 2 indicates that contamination is caused by generation of only non-conductive substances. In this degree, however, temporary conduction may be caused by accidental condensation.

### 5.2 Input specifications

Item	Specification	
<b>Input method</b>	DC input (using module power supply in common)	
<b>Number of input</b>	1 point	
<b>Isolation method</b>	Isolation with photocoupler	
<b>Rated input voltage</b>	24V DC	
<b>Rated input current</b>	Approx. 4 mA	
<b>Operating voltage range</b>	Same as module power supply	
<b>Max. simultaneous ON input points</b>	100% (at 24V DC)	
<b>ON voltage/ON current</b>	19 V or more/3 mA or more	
<b>OFF voltage/OFF current</b>	11 V or less/1.7 mA or less	
<b>Input resistance</b>	5.6 kΩ	
<b>Response time</b>	<b>OFF→ON</b>	1.5 ms or less (at 24V DC)
	<b>ON→OFF</b>	1.5 ms or less (at 24V DC)
<b>Common wiring method</b>	1 point/1 common (Mutually exclusive output)	

## 5.3 Output specifications

Item	Specification	
<b>Output method</b>	Transistor output (using module power supply in common) (sink)	
<b>Number of output</b>	1 point	
<b>Isolation method</b>	Isolation with photocoupler	
<b>Rated load voltage</b>	24V DC	
<b>Operating load voltage range</b>	Same as module power supply	
<b>Max. load current</b>	0.1A/point 0.2 A/1 common	
<b>Max. inrush current</b>	0.4A/10 ms	
<b>Leakage current at OFF</b>	0.1mA or less/30V DC	
<b>Max. voltage drop at ON</b>	1V or less (max.)/0.1A	
<b>Response time</b>	<b>OFF→ON</b>	1.0ms or less
	<b>ON→OFF</b>	1.0ms or less
<b>Surge suppression</b>	Zener diode	
<b>Common wiring method</b>	1 point/1 common (Mutually exclusive output)	
<b>Internal protection for outputs</b>	Internal protection circuit none Please connect the fuse in the connected load outside.	

### 5.4 Performance specifications

Item	Specification	
<b>Module power supply</b>	<b>Voltage</b>	20.4 to 28.8V DC (24V DC -15% to +20%) Ripple ratio: Within 5%
	<b>Current consumption</b>	40mA (when all points are ON) (Current consumption contains neither the input current nor the load current.)
	<b>Initial current</b>	70mA
	<b>Max. allowable momentary power failure period</b>	PS1:1ms
<b>Number of stations occupied</b>	4-, 8- or 16-point mode: 1 station	
<b>Noise durability</b>	500Vp-p Noise width: 1μs Cycle: 25 to 60 Hz (by noise simulator)	
<b>Withstand voltage</b>	500V AC for 1 min	
<b>Isolation resistance</b>	10 MΩ or more between primary area (external DC terminal) and secondary area (internal circuit) by 500V DC megger	
<b>Protection class</b>	IP2X	
<b>I/O part connection method</b>	Connection with cable	
<b>Module installation method</b>	Can be installed in six directions	
<b>Flat cable for I/O (wire diameter)</b>	AWG18 (34/0.18)	
<b>Mass (weight)</b>	0.07 kg (0.15 lbs) (including 500mm (19.69") flat cable dedicated to CC-Link/LT and 500mm (19.69") flat cable for I/O)	

## 6. Outside Dimensions

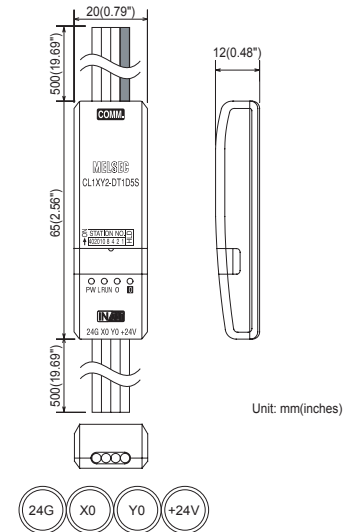

Unit: mm(inches)

This manual confers no industrial property rights or any rights of any other kind, nor does it confer any patent licenses. Mitsubishi Electric Corporation cannot be held responsible for any problems involving industrial property rights which may occur as a result of using the contents noted in this manual.

#### Warranty

Mitsubishi will not be held liable for damage caused by factors found not to be the cause of Mitsubishi; machine damage or lost profits caused by faults in the Mitsubishi products; damage, secondary damage, accident compensation caused by special factors unpredictable by Mitsubishi; damages to products other than Mitsubishi products; and to other duties.

#### For safe use

- This product has been manufactured as a general-purpose part for general industries, and has not been designed or manufactured to be incorporated in a device or system used in purposes related to human life.
- Before using the product for special purposes such as nuclear power, electric power, aerospace, medicine or passenger movement vehicles, consult with Mitsubishi.
- This product has been manufactured under strict quality control. However when installing the product where major accidents or losses could occur if the product fails, install appropriate backup or failsafe functions in the system.

Country/Region	Sales office/Tel	Country/Region	Sales office/Tel
U.S.A.	Mitsubishi Electric Automation, Inc. 500 Corporate Woods Parkway, Vernon Hills, IL 60061 U.S.A. Tel: -1-847-478-2100	Hong Kong	Mitsubishi Electric Automation (Hong Kong) Ltd. 10th Floor, Manulife Tower, 169 Electric Road, North Point, HongKong Tel: +852-2887-8870
Brazil	MELCO-TEC Av. Paulista 1439, conj.74, Bela Vista CEP: 01311-200 Sao Paulo-SP-Brazil Tel: +55-11-3285-1840	China	Mitsubishi Electric Automation (Shanghai) Ltd. 17F, ChuangXing Financial Center, No. 293 West Nanjing Road, Shanghai China 200003 Tel: +86-21-2322-3030
Germany	Mitsubishi Electric Europe B.V. German Branch Gothaer Strasse 8, D-40880 Ratingen, Germany Tel: +49-2102-486-0	Taiwan	Setuwo Enterprise Co., Ltd. BF No.105 Wu Kung 3rd RD, Wu-Ku Hsiang, Taipei Hsien, 248, Taiwan Tel: +886-2-2208-2499
U.K.	Mitsubishi Electric Europe B.V. UK Branch Travellers Lane, Hatfield, Hertfordshire, AL10 8XB, U.K. Tel: +44-1707-276100	Korea	SE 1480-6, Gayang-Dong, Gangseo-Gu, Seoul, 157-200, Korea Tel: +82-2-3690-9552
Italy	Mitsubishi Electric Europe B.V. Italian Branch VIALE COLLEONI 7-20041 Agrate Brianza (Milano), Italy Tel: +390-39-60531	Singapore	Mitsubishi Electric Asia Pte. Ltd. 307 Alexandra Road #05-01/02 Mitsubishi Electric Building, Singapore 159943 Tel: +65-6470-2460
Spain	Mitsubishi Electric Europe B.V. Spanish Branch Ctra. de Rub 76-80-AC, 420, E-08190 Sant Cugat del Valles (Barcelona), Spain Tel: +34-93-565-3131	Thailand	Mitsubishi Electric Automation (Thailand) Co., Ltd. Bang-Chan Industrial Estate No.111, Soi Sathai 54, T.Kanayao, A.Kanayao, Bangkok 10230 Tel: +66-2-651-1326
France	Mitsubishi Electric Europe B.V. French Branch 25, Boulevard des Bouvets, F-92741 Nanterre Cedex, France Tel: +33-1-55685698	India	Messuro Systems Pvt. Ltd. Sapphire House EL-3 J-Block MIDC Bhasan Pune-411026, India Tel: +91-20-27102000
Russia	Mitsubishi Electric Europe B.V. Moscow Representative Office 52, bid. 5, Kosmodamianskaya nab, RU-115054, Moscow, Russia Tel: +7-495-721-2070	Australia	Mitsubishi Electric Australia Pty. Ltd. 345 Victoria Road, Rydalmere, N.S.W 2116, Australia Tel: +61-2-9684-7777
		South Africa	Circuit Breaker Industries Ltd. Private Bag 2016, ZA-1600 Isando, South Africa Tel: +27-11-92822000

**MITSUBISHI ELECTRIC CORPORATION**  
HEAD OFFICE : TOKYO BUILDING, 2-7-3 MARUNOUCHI, CHYODA-KU, TOKYO 100-8310, JAPAN  
HIMEJI WORKS : 840, CHYODA CHO, HIMEJI, JAPAN

When exported from Japan, this manual does not require application to the Ministry of Economy, Trade and Industry for service transaction permission.

Specifications subject to change without notice.



Please read this manual thoroughly before starting to use the product and handle the product properly.

## User's Manual

MODEL	CL1XY2-DT1D5S
MANUAL Number	JY997D03801G
Date	September 2008

**SAFETY PRECAUTIONS**  
 (Read these precautions before using)  
 Please read this manual carefully and pay special attention to safety in order to handle this product properly. Also pay careful attention to safety and handle the module properly.  
 These precautions apply only to Mitsubishi equipment. Refer to the user's manual of the CPU module to use for a description of the PLC system safety precautions.  
 These **SAFETY PRECAUTIONS** classify the safety precautions into two categories: "DANGER" and "CAUTION".

<b>DANGER</b>	Procedures which may lead to a dangerous condition and cause death or serious injury if not carried out properly.
<b>CAUTION</b>	Procedures which may lead to a dangerous condition and cause superficial to medium injury, or physical damage only, if not carried out properly.

Depending on circumstances, procedures indicated by **CAUTION** may also be linked to serious results.  
 In any case, it is important to follow the directions for usage.  
 Store this manual in a safe place so that you can take it out and read it whenever necessary. Always forward it to the end user.

### DESIGN PRECAUTIONS

**DANGER**  
 • Configure an interlock circuit in a sequence program so that the system operates on the safety side using the communication status information in the event the data link falls into a communication problem.  
 Otherwise, erroneous output and malfunction may result in accidents.  
 • Remote input and output can not be switched ON or OFF when a problem occurs in the remote I/O modules. Therefore build an external monitoring circuit that will monitor any input signals that could cause a serious accident.

**CAUTION**  
 • Do not have control cables and connection cables bundled with or placed near by the main circuit and/or power cables. Wire those cables at least 100mm(3.94 inch) away from the main circuit and/or power cables. It may cause malfunction due to noise interference.  
 • Use the module in the status in which any force is not applied on the module, flat cables dedicated to CC-Link/LT and flat cables for I/O. If a force is applied, wire breakage or failure may be caused.

### INSTALLATION PRECAUTIONS

**CAUTION**  
 • Use the module in an environment that meets the general specifications contained in this manual. Using this module in an environment outside the range of the general specifications could result in electric shock, fire, erroneous operation, and damage to or deterioration of the product.  
 • Do not directly touch the module's conductive parts. Doing so could cause malfunction or trouble in the module.

### WIRING PRECAUTIONS

**DANGER**  
 • Perform installation and wiring after disconnecting the power supply at all phases externally. If the power is not disconnected at all phases an electric shock or product damage may result.

**CAUTION**  
 • Perform correct wiring for the module according to the product's rated voltage and terminal arrangement. Connecting to a power supply different from rating or miss-wiring may cause fire, product failure or malfunction.  
 • Make sure foreign objects do not get inside the module, such as dirt and wire chips. It may cause fire, product failure or malfunction.  
 • Do not short-circuit the 24G and +24V terminals. It may result in fire, product failure or malfunction.  
 • Attach a warning label (hazard symbol 417-IEC-5036) concerning the electric shock to the location.

### STARTING AND MAINTENANCE PRECAUTIONS

**DANGER**  
 • Do not touch the terminals when the power is ON. It may cause an electric shock or malfunction.  
 • Perform cleaning the module after turning OFF the all external power supply for sure. Failure to do so may cause failure or malfunction of the modules.

**CAUTION**  
 • Do not disassemble or modify the module. Doing so may cause failure, malfunction, injury, or fire.  
 • The module case is made of resin; do not drop it or subject it to strong shock. A module damage may result.  
 • Make sure to switch all phases of the external power supply OFF before installing or removing the module to/from the panel. Failure to do so may cause failure or malfunction of the modules.

### DISPOSAL PRECAUTIONS

**DANGER**  
 • When disposing of this product, treat it as industrial waste.

### TRANSPORTATION AND MAINTENANCE PRECAUTIONS

**CAUTION**  
 • During transportation avoid any impact as the module is a precision instrument. Doing so could cause trouble in the module.  
 • If it is necessary to check the operation of module after transportation, in case of any impact damage.

**Notification of CE marking**  
 This notification does not guarantee that an entire mechanical module produced in accordance with the contents of the notification comply with the following standards. Compliance to EMC standards of the entire mechanical module should be checked by the user / manufacturer.

**Standards with which this product complies**  
 Type : Programmable Controller (Open Type Equipment) Remote I/O module  
 Models : Products manufactured:  
 from November 1st, 2002 to April 30th, 2006 are compliant with EN61000-6-4 and EN61131-2:1994+A11:1996+A12:2000 after May 1st, 2006 are compliant with EN61131-2:2003

Electromagnetic Compatibility Standards (EMC)	Remark
EN61000-6-4:2001 Electromagnetic compatibility -Generic standards - Emission standard for Industrial environment	Compliance with all relevant aspects of the standard. (Radiated Emissions and Mains Terminal Voltage Emissions)
EN61131-2:1994/A11:1996/A12:2000 Programmable controllers -Equipment requirements and tests	Compliance with all relevant aspects of the standard. (RF Immunity, Fast transients, ESD and Damped oscillatory wave)
EN61131-2:2003 Programmable controllers -Equipment requirements and tests	Compliance with all relevant aspects of the standard. (Radiated Emissions, Mains Terminal Voltage Emissions, RF immunity, Fast Transients, ESD, Surge, Voltage drops and interruptions, Conducted and Power magnetic fields)

For more details please contact the local Mitsubishi Electric sales site.  
 - Notes For compliance to EMC regulation.  
 It is necessary to install the CL1 series module in a shielded metal control panel.

## 1. Outline of Product

This product is a cable type composite I/O module connected to CC-Link/LT. This product has one input point (24V DC) and one output point (transistor output).

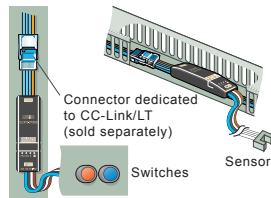

## 2. Name and Setting of Each Part

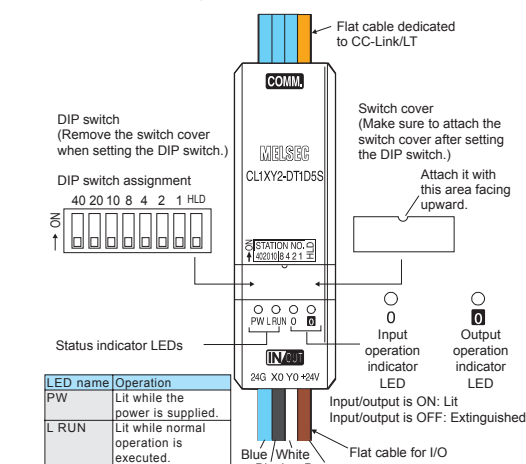

Name	Description																								
Status indicator LED	PW ON while the power is supplied. L RUN ON while normal operation is executed.																								
I/O operation indicator LED	ON while the input or output is ON. Extinguished while the input or output is OFF. X0 input operation indicator LED Y0 output operation indicator LED																								
Flat cable dedicated to CC-Link/LT	24G DB DA +24V Connector for CC-Link/LT communication line/module power supply																								
Flat cable for I/O	Blue 24G Black X0 White Y0 Brown +24V																								
DIP switch	Set the 10's digit of the station No. using "STATION NO. 10", "STATION NO. 20" and "STATION NO. 40". Set the 1's digit of the station No. using "STATION NO. 1", "STATION NO. 2", "STATION NO. 4" and "STATION NO. 8". Factory default = All bits are OFF. Make sure to set the station No. in the range from 1 to 64. Example: When setting the station No. to "32", set the DIP switch as follows. <table border="1"> <tr> <th>Station No.</th> <th>10's digit</th> <th>1's digit</th> </tr> <tr> <td>40</td> <td>OFF</td> <td>ON</td> </tr> <tr> <td>20</td> <td>ON</td> <td>ON</td> </tr> <tr> <td>10</td> <td>ON</td> <td>OFF</td> </tr> <tr> <td>8</td> <td>OFF</td> <td>OFF</td> </tr> <tr> <td>4</td> <td>OFF</td> <td>ON</td> </tr> <tr> <td>2</td> <td>ON</td> <td>OFF</td> </tr> <tr> <td>1</td> <td>OFF</td> <td>OFF</td> </tr> </table>	Station No.	10's digit	1's digit	40	OFF	ON	20	ON	ON	10	ON	OFF	8	OFF	OFF	4	OFF	ON	2	ON	OFF	1	OFF	OFF
Station No.	10's digit	1's digit																							
40	OFF	ON																							
20	ON	ON																							
10	ON	OFF																							
8	OFF	OFF																							
4	OFF	ON																							
2	ON	OFF																							
1	OFF	OFF																							

Name	Description
DIP switch	HLD Holds the output (when an error has occurred). ON: Holds the output. OFF: Clears the output.

## 3. Cautions on Handling

### 3.1 Handling of flat cable for I/O

The cable length from the module to a sensor shall be within 3m(9'10"). Measure the cable outside the module, and confirm that the driving voltage for the used sensor is assured.

#### • Input

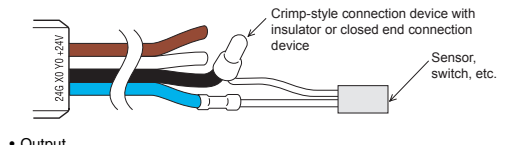

#### • Output

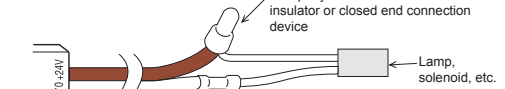

If the diameter of the I/O equipment connection cable is equivalent to the diameter of the flat cable for I/O of this module, connectors dedicated to CC-Link/LT can be used for connection.

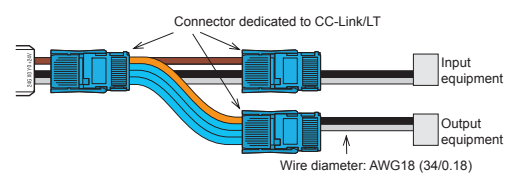

### 3.2 Handling of cable

Do not bend the cable within 30mm(1.18") from the module.

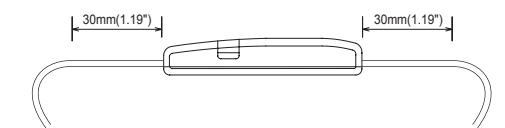

Use a crimp-style terminal in a status in which no force is applied on the cable.

### 3.3 Mounting with the CL1-HLD (module holder)

Refer to the figures below for details on mounting or removing the remote I/O module when used with the CL1-HLD.

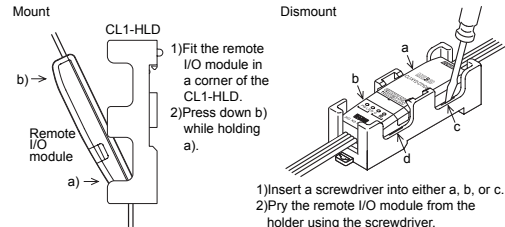

## 4. Wiring

### 4.1 External wiring

The input and output terminals of the CL1XY2-DT1D5S operate while using the power supplied from the interface.  
 When connecting a sensor to the input terminal, use a sensor of the NPN open collector transistor type.  
 The output wiring is fixed to the sink output.

### I/O wiring

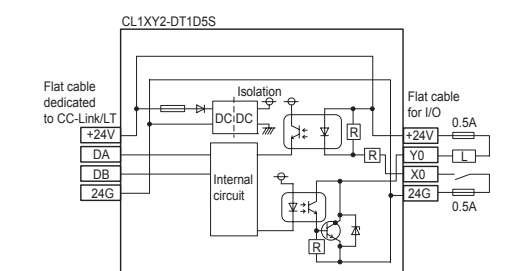

### 4.2 Connection to sensor

• When using a two-wire type sensor • When using a three-wire type sensor

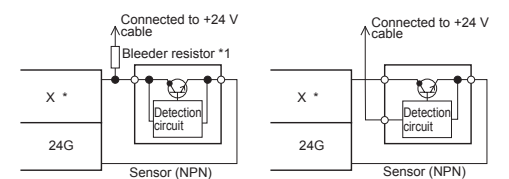

Replace \* in the figure with the used input No.

Notes:

\*1 Bleeder resistor  
 When connecting a two-wire type sensor or input equipment having parallel resistor, select a sensor or equipment whose leakage current is 1.7mA or less.  
 If the leakage current is more than 1.7mA, connect a bleeder resistor obtained in the following calculation formula.

Circuit image

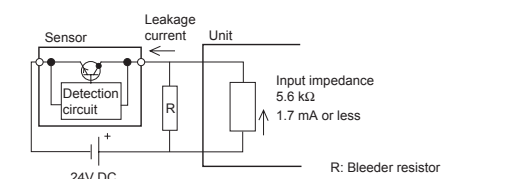

$$R(k\Omega) < 1.7(mA) / \text{Leakage current}(mA) - 1.7(mA) \times 5.6(k\Omega)$$

The power capacity W of the bleeder resistor R is as follows:

$$W = (\text{Input voltage})^2 / R$$

• Make sure that both the ON and OFF time of the input signal are 1.5ms or more.

## 5. Specifications

### 5.1 General specifications

Item	Specification
Ambient working temperature	0 to 55°C (32 to 131°F)
Ambient storage temperature	-25 to 75°C (-13 to 167°F)
Ambient operating humidity	5 to 95%RH: Dew condensation shall not be considered.
Ambient storage humidity	5 to 95%RH: Dew condensation shall not be considered.
Vibration resistance	When intermittent vibration is present Frequency Acceleration Half amplitude 10 to 57Hz - 0.075mm 57 to 150Hz 9.8m/s <sup>2</sup> - When continuous vibration is present Frequency Acceleration Half amplitude 10 to 57Hz - 0.035mm 57 to 150Hz 4.9m/s <sup>2</sup> - 10 times in each of X, Y and Z directions (for 80 min)
Impact resistance	147 m/s <sup>2</sup> , 3 times in each of X, Y and Z directions
Operating atmosphere	Corrosive gas shall not be present.
Operating altitude	2,000m(6561'8") or less(*1)
Installation place	Inside control panel (*2)
Over-voltage category	II or less(*3)
Degree of contamination	2 or less (*4)

Notes:

\*1 The module cannot be used in an environment pressurized above the atmospheric pressure which can be generated around the altitude of 0 m. If the module is used in such an environment, it may fail.  
 \*2 The module can be used in any environment even outside the control panel as far as the requirements of the ambient operating temperature, the ambient operating humidity, etc. are satisfied.  
 \*3 This indicates the section of the power supply to which the equipment is assumed to be connected between the public electrical power distribution network and the machinery within premises. Category II applies to equipment for which electrical power is supplied from fixed facilities.  
 The surge voltage withstand level for up to the rated voltage of 300V is 2500V.  
 \*4 This index indicates the degree of conductive generating substances in the environment in which the module is used. The degree of contamination 2 indicates that contamination is caused by generation of only non-conductive substances. In this degree, however, temporary conduction may be caused by accidental condensation.

### 5.2 Input specifications

Item	Specification
Input method	DC input (using module power supply in common)
Number of input	1 point
Isolation method	Isolation with photocoupler
Rated input voltage	24V DC
Rated input current	Approx. 4 mA
Operating voltage range	Same as module power supply
Max. simultaneous ON input points	100% (at 24V DC)
ON voltage/ON current	19 V or more/3 mA or more
OFF voltage/OFF current	11 V or less/1.7 mA or less
Input resistance	5.6 kΩ
Response time	OFF→ON 1.5 ms or less (at 24V DC) ON→OFF 1.5 ms or less (at 24V DC)
Common wiring method	1 point/1 common (Mutually exclusive output)

### 5.3 Output specifications

Item	Specification
Output method	Transistor output (using module power supply in common) (sink)
Number of output	1 point
Isolation method	Isolation with photocoupler
Rated load voltage	24V DC
Operating load voltage range	Same as module power supply
Max. load current	0.1A/point 0.2 A/1 common
Max. inrush current	0.4A/10 ms
Leakage current at OFF	0.1mA or less/30V DC
Max. voltage drop at ON	1V or less (max.)/0.1A
Response time	OFF→ON 1.0ms or less ON→OFF 1.0ms or less
Surge suppression	Zener diode
Common wiring method	1 point/1 common (Mutually exclusive output)
Internal protection for outputs	Internal protection circuit none Please connect the fuse in the connected load outside.

### 5.4 Performance specifications

Item	Specification	
Module power supply	Voltage	20.4 to 28.8V DC (24V DC -15% to +20%) Ripple ratio: Within 5%
	Current consumption	40mA (when all points are ON) (Current consumption contains neither the input current nor the load current.)
	Initial current	70mA
	Max. allowable momentary power failure period	PS1:1ms
Number of stations occupied	4-, 8- or 16-point mode: 1 station	
Noise durability	500Vp-p Noise width: 1μs Cycle: 25 to 60 Hz (by noise simulator)	
Withstand voltage	500V AC for 1 min	
Isolation resistance	10 MΩ or more between primary area (external DC terminal) and secondary area (internal circuit) by 500V DC megger	
Protection class	IP2X	
I/O part connection method	Connection with cable	
Module installation method	Can be installed in six directions	
Flat cable for I/O (wire diameter)	AWG18 (34/0.18)	
Mass (weight)	0.07 kg (0.15 lbs) (including 500mm (19.69") flat cable dedicated to CC-Link/LT and 500mm (19.69") flat cable for I/O)	

## 6. Outside Dimensions

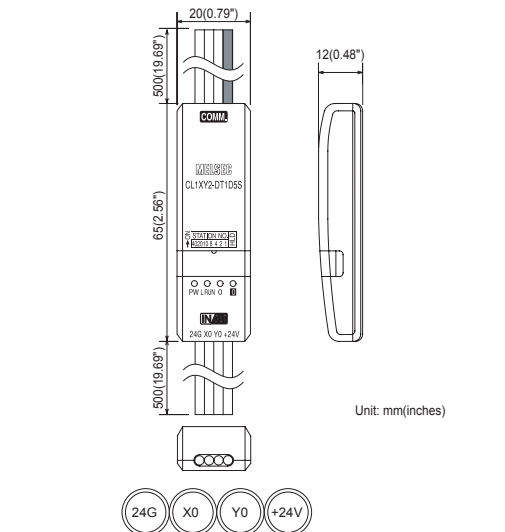

This manual confers no industrial property rights or any rights of any other kind, nor does it confer any patent licenses. Mitsubishi Electric Corporation cannot be held responsible for any problems involving industrial property rights which may occur as a result of using the contents noted in this manual.

### Warranty

Mitsubishi will not be held liable for damage caused by factors found not to be the cause of Mitsubishi; machine damage or lost profits caused by faults in the Mitsubishi products; damage, secondary damage, accident compensation caused by special factors unpredictable by Mitsubishi; damages to products other than Mitsubishi products; and to other duties.

### For safe use

• This product has been manufactured as a general-purpose part for general industries, and has not been designed or manufactured to be incorporated in a device or system used in purposes related to human life.  
 • Before using the product for special purposes such as nuclear power, electric power, aerospace, medicine or passenger movement vehicles, consult with Mitsubishi.  
 • This product has been manufactured under strict quality control. However when installing the product where major accidents or losses could occur if the product fails, install appropriate backup or failsafe functions in the system.

Country/Region	Sales office/Tel	Country/Region	Sales office/Tel
U.S.A.	Mitsubishi Electric Automation, Inc. 500 Corporate Woods Parkway, Vernon Hills, IL 60061 U.S.A. Tel: +1-847-478-2100	Hong Kong	Mitsubishi Electric Automation (Hong Kong) Ltd. 10th Floor, Manulife Tower, 169 Electric Road, North Point, HongKong
Brazil	MELCO-TEC Av. Paulista 1439, cont. 74, Bela Vista CEP: 01311-200 São Paulo-SP-Brazil Tel: +55-11-3285-1840	China	Mitsubishi Electric Automation (Shanghai) Ltd. 17F, ChuangXing Financial Center, No. 288 West Nanjing Road, Shanghai, China 200003 Tel: +86-21-2322-3030 Setajoy Enterprise Co., Ltd. #F No. 105 Wu Kong 3rd RD, Wu-Ku Hsing, Taipei Hsien, 248, Taiwan Tel: +886-2-2259-2459
Germany	Mitsubishi Electric Europe B.V. German Branch Gothaer Strasse 8, D-40880 Ratingen, Germany Tel: +49-2102-486-0	Taiwan	Mitsubishi Electric Automation (Taiwan) Co., Ltd. Bang-Chan Industrial Estate No. 111, Soi Serthai 54, 1 Kamayao, A.Kamayao, Bangkok 10210 Tel: +66-2-517-1326
UK	Mitsubishi Electric Europe B.V. UK Branch Travellers Lane, Hatfield, Hertfordshire, AL10 8XB, U.K. Tel: +44-1703-278100	Korea	Mitsubishi Electric Automation Korea Co., Ltd. 3F, 1480-6, Gayang-Dong, Gangseo-Gu, Seoul, 157-200, Korea Tel: +82-2-3669-9552
Italy	Mitsubishi Electric Europe B.V. Italian Branch VIALE COLLEONI 7-20041 Agrate Brianza (Milano), Italy Tel: +39-039-60531	Singapore	Mitsubishi Electric Building, Singapore 159943 Tel: +65-6475-2460
Spain	Mitsubishi Electric Europe B.V. Spanish Branch Ctra. de Rub 76-80-A.C. 420, E-08190 Sant Cugat del Valles (Barcelona), Spain Tel: +34-93-655-3131	Thailand	Mitsubishi Electric Automation (Thailand) Co., Ltd. Bang-Chan Industrial Estate No. 111, Soi Serthai 54, 1 Kamayao, A.Kamayao, Bangkok 10210 Tel: +66-2-517-1326
France	Mitsubishi Electric Europe B.V. French Branch 25, Boulevard des Bouvets, F-92741 Nanterre Cedex, France Tel: +33-1-55855558	India	Messung Systems Pvt. Ltd. Sapphire House EL-3, J-Block MIDC Bhorani Pune 411026, India Tel: +91-20-27102050
Russia	Mitsubishi Electric Europe B.V. Moscow Representative Office 52, bld. 5, Kosmodemianskaya nab. RU-115054, Moscow, Russia Tel: +7-495-721-2070	Australia	Mitsubishi Electric Australia Pty. Ltd. 348 Victoria Road, Rydalmere, N.S.W. 2116, Australia Tel: +61-2-9684-7777
		South Africa	Circuit Breaker Industries Ltd. Private Bag 2016, ZA-1600 Isando, South Africa Tel: +27-11-9282000

**MITSUBISHI ELECTRIC CORPORATION**  
 HEAD OFFICE : TOKYO BUILDING, 2-7-3 MARUNOUCHI, CHYODA-KU, TOKYO 100-8310, JAPAN  
 HINEJI WORKS : #60, CHYODA CHO, HINEJI, JAPAN

When exported from Japan, this manual does not require application to the Ministry of Economy, Trade and Industry for service translation permission.  
 Specifications subject to change without notice.