



Mitsubishi Programmable Controller

MELSEC iQ-R
series

MELSEC iQ-R Channel Isolated Thermocouple
Input Module/Channel Isolated RTD Input Module
User's Manual (Startup)

-R60TD8-G
-R60RD8-G



SAFETY PRECAUTIONS

(Read these precautions before using this product.)

Before using this product, please read this manual and the relevant manuals carefully and pay full attention to safety to handle the product correctly.

The precautions given in this manual are concerned with this product only. For the safety precautions of the programmable controller system, refer to the MELSEC iQ-R Module Configuration Manual.

In this manual, the safety precautions are classified into two levels: "⚠️ WARNING" and "⚠️ CAUTION".

 WARNING	Indicates that incorrect handling may cause hazardous conditions, resulting in death or severe injury.
 CAUTION	Indicates that incorrect handling may cause hazardous conditions, resulting in minor or moderate injury or property damage.

Under some circumstances, failure to observe the precautions given under "⚠️ CAUTION" may lead to serious consequences.

Observe the precautions of both levels because they are important for personal and system safety.

Make sure that the end users read this manual and then keep the manual in a safe place for future reference.

[Design Precautions]

WARNING

- Configure safety circuits external to the programmable controller to ensure that the entire system operates safely even when a fault occurs in the external power supply or the programmable controller. Failure to do so may result in an accident due to an incorrect output or malfunction.
 - (1) Emergency stop circuits, protection circuits, and protective interlock circuits for conflicting operations (such as forward/reverse rotations or upper/lower limit positioning) must be configured external to the programmable controller.
 - (2) When the programmable controller detects an abnormal condition, it stops the operation and all outputs are:
 - Turned off if the overcurrent or overvoltage protection of the power supply module is activated.
 - Held or turned off according to the parameter setting if the self-diagnostic function of the CPU module detects an error such as a watchdog timer error.
 - (3) All outputs may be turned on if an error occurs in a part, such as an I/O control part, where the CPU module cannot detect any error. To ensure safety operation in such a case, provide a safety mechanism or a fail-safe circuit external to the programmable controller. For a fail-safe circuit example, refer to "General Safety Requirements" in the MELSEC iQ-R Module Configuration Manual.
 - (4) Outputs may remain on or off due to a failure of a component such as a relay and transistor in an output circuit. Configure an external circuit for monitoring output signals that could cause a serious accident.
 - In an output circuit, when a load current exceeding the rated current or an overcurrent caused by a load short-circuit flows for a long time, it may cause smoke and fire. To prevent this, configure an external safety circuit, such as a fuse.
 - Configure a circuit so that the programmable controller is turned on first and then the external power supply. If the external power supply is turned on first, an accident may occur due to an incorrect output or malfunction.
 - For the operating status of each station after a communication failure, refer to manuals relevant to the network. Incorrect output or malfunction due to a communication failure may result in an accident.
-

[Design Precautions]

WARNING

- When connecting an external device with a CPU module or intelligent function module to modify data of a running programmable controller, configure an interlock circuit in the program to ensure that the entire system will always operate safely. For other forms of control (such as program modification, parameter change, forced output, or operating status change) of a running programmable controller, read the relevant manuals carefully and ensure that the operation is safe before proceeding. Improper operation may damage machines or cause accidents.
 - Especially, when a remote programmable controller is controlled by an external device, immediate action cannot be taken if a problem occurs in the programmable controller due to a communication failure. To prevent this, configure an interlock circuit in the program, and determine corrective actions to be taken between the external device and CPU module in case of a communication failure.
 - Do not write any data to the "system area" and "write-protect area" of the buffer memory in the module. Also, do not use any "use prohibited" signals as an output signal from the CPU module to each module. Doing so may cause malfunction of the programmable controller system. For the "system area", "write-protect area", and the "use prohibited" signals, refer to the user's manual for the module used.
 - If a communication cable is disconnected, the network may be unstable, resulting in a communication failure of multiple stations. Configure an interlock circuit in the program to ensure that the entire system will always operate safely even if communications fail. Failure to do so may result in an accident due to an incorrect output or malfunction.
 - To maintain the safety of the programmable controller system against unauthorized access from external devices via the network, take appropriate measures. To maintain the safety against unauthorized access via the Internet, take measures such as installing a firewall.
-

[Design Precautions]

CAUTION

- Do not install the control lines or communication cables together with the main circuit lines or power cables. Keep a distance of 100mm or more between them. Failure to do so may result in malfunction due to noise.
 - During control of an inductive load such as a lamp, heater, or solenoid valve, a large current (approximately ten times greater than normal) may flow when the output is turned from off to on. Therefore, use a module that has a sufficient current rating.
 - After the CPU module is powered on or is reset, the time taken to enter the RUN status varies depending on the system configuration, parameter settings, and/or program size. Design circuits so that the entire system will always operate safely, regardless of the time.
 - Do not power off the programmable controller or reset the CPU module while the settings are being written. Doing so will make the data in the flash ROM undefined. The values need to be set in the buffer memory and written to the flash ROM again. Doing so also may cause malfunction or failure of the module.
 - When changing the operating status of the CPU module from external devices (such as the remote RUN/STOP functions), select "Do Not OPEN in Program" for "Open Method Setting" in the module parameters. If "OPEN in Program" is selected, an execution of the remote STOP function causes the communication line to close. Consequently, the CPU module cannot reopen the line, and external devices cannot execute the remote RUN function.
-

[Installation Precautions]

WARNING

- Shut off the external power supply (all phases) used in the system before mounting or removing the module. Failure to do so may result in electric shock or cause the module to fail or malfunction.
-

[Installation Precautions]

CAUTION

- Use the programmable controller in an environment that meets the general specifications in the Safety Guidelines included with the base unit. Failure to do so may result in electric shock, fire, malfunction, or damage to or deterioration of the product.
 - To mount a module, place the concave part(s) located at the bottom onto the guide(s) of the base unit, and push in the module until the hook(s) located at the top snaps into place. Incorrect interconnection may cause malfunction, failure, or drop of the module.
 - When using the programmable controller in an environment of frequent vibrations, fix the module with a screw.
 - Tighten the screws within the specified torque range. Undertightening can cause drop of the screw, short circuit, or malfunction. Overtightening can damage the screw and/or module, resulting in drop, short circuit, or malfunction.
 - When using an extension cable, connect it to the extension cable connector of the base unit securely. Check the connection for looseness. Poor contact may cause malfunction.
 - When using an SD memory card, fully insert it into the SD memory card slot. Check that it is inserted completely. Poor contact may cause malfunction.
 - Securely insert an extended SRAM cassette into the cassette connector of the CPU module. After insertion, close the cassette cover and check that the cassette is inserted completely. Poor contact may cause malfunction.
 - Do not directly touch any conductive parts and electronic components of the module, SD memory card, extended SRAM cassette, or connector. Doing so can cause malfunction or failure of the module.
-

[Wiring Precautions]

WARNING

- Shut off the external power supply (all phases) used in the system before installation and wiring. Failure to do so may result in electric shock or cause the module to fail or malfunction.
 - After installation and wiring, attach the included terminal cover to the module before turning it on for operation. Failure to do so may result in electric shock.
-

[Wiring Precautions]

CAUTION

- Individually ground the FG and LG terminals of the programmable controller with a ground resistance of 100 ohms or less. Failure to do so may result in electric shock or malfunction.
- Use applicable solderless terminals and tighten them within the specified torque range. If any spade solderless terminal is used, it may be disconnected when the terminal screw comes loose, resulting in failure.
- Check the rated voltage and signal layout before wiring to the module, and connect the cables correctly. Connecting a power supply with a different voltage rating or incorrect wiring may cause fire or failure.
- Connectors for external devices must be crimped or pressed with the tool specified by the manufacturer, or must be correctly soldered. Incomplete connections may cause short circuit, fire, or malfunction.
- Securely connect the connector to the module. Poor contact may cause malfunction.
- Do not install the control lines or communication cables together with the main circuit lines or power cables. Keep a distance of 100mm or more between them. Failure to do so may result in malfunction due to noise.
- Place the cables in a duct or clamp them. If not, dangling cable may swing or inadvertently be pulled, resulting in damage to the module or cables or malfunction due to poor contact. Do not clamp the extension cables with the jacket stripped.
- Check the interface type and correctly connect the cable. Incorrect wiring (connecting the cable to an incorrect interface) may cause failure of the module and external device.
- Tighten the terminal screws or connector screws within the specified torque range. Undertightening can cause drop of the screw, short circuit, fire, or malfunction. Overtightening can damage the screw and/or module, resulting in drop, short circuit, fire, or malfunction.
- When disconnecting the cable from the module, do not pull the cable by the cable part. For the cable with connector, hold the connector part of the cable. For the cable connected to the terminal block, loosen the terminal screw. Pulling the cable connected to the module may result in malfunction or damage to the module or cable.
- Prevent foreign matter such as dust or wire chips from entering the module. Such foreign matter can cause a fire, failure, or malfunction.
- A protective film is attached to the top of the module to prevent foreign matter, such as wire chips, from entering the module during wiring. Do not remove the film during wiring. Remove it for heat dissipation before system operation.
- Programmable controllers must be installed in control panels. Connect the main power supply to the power supply module in the control panel through a relay terminal block. Wiring and replacement of a power supply module must be performed by qualified maintenance personnel with knowledge of protection against electric shock. For wiring, refer to the MELSEC iQ-R Module Configuration Manual.
- For Ethernet cables to be used in the system, select the ones that meet the specifications in the user's manual for the module used. If not, normal data transmission is not guaranteed.
- Individually ground the shielded cables of the programmable controller with a ground resistance of 100 ohms or less. Failure to do so may result in electric shock or malfunction.

[Precautions for using channel isolated thermocouple input modules]

- Do not place the module near a device that generates magnetic noise.
-

[Startup and Maintenance Precautions]

WARNING

- Do not touch any terminal while power is on. Doing so will cause electric shock or malfunction.
 - Correctly connect the battery connector. Do not charge, disassemble, heat, short-circuit, solder, or throw the battery into the fire. Also, do not expose it to liquid or strong shock. Doing so will cause the battery to produce heat, explode, ignite, or leak, resulting in injury and fire.
 - Shut off the external power supply (all phases) used in the system before cleaning the module or retightening the terminal screws, connector screws, or module fixing screws. Failure to do so may result in electric shock.
-

[Startup and Maintenance Precautions]

CAUTION

- When connecting an external device with a CPU module or intelligent function module to modify data of a running programmable controller, configure an interlock circuit in the program to ensure that the entire system will always operate safely. For other forms of control (such as program modification, parameter change, forced output, or operating status change) of a running programmable controller, read the relevant manuals carefully and ensure that the operation is safe before proceeding. Improper operation may damage machines or cause accidents.
 - Especially, when a remote programmable controller is controlled by an external device, immediate action cannot be taken if a problem occurs in the programmable controller due to a communication failure. To prevent this, configure an interlock circuit in the program, and determine corrective actions to be taken between the external device and CPU module in case of a communication failure.
 - Do not disassemble or modify the modules. Doing so may cause failure, malfunction, injury, or a fire.
 - Use any radio communication device such as a cellular phone or PHS (Personal Handy-phone System) more than 25cm away in all directions from the programmable controller. Failure to do so may cause malfunction.
 - Shut off the external power supply (all phases) used in the system before mounting or removing the module. Failure to do so may cause the module to fail or malfunction.
 - Tighten the screws within the specified torque range. Undertightening can cause drop of the component or wire, short circuit, or malfunction. Overtightening can damage the screw and/or module, resulting in drop, short circuit, or malfunction.
 - After the first use of the product, do not mount/remove the module to/from the base unit, and the terminal block to/from the module, and do not insert/remove the extended SRAM cassette to/from the CPU module more than 50 times (IEC 61131-2 compliant) respectively. Exceeding the limit may cause malfunction.
 - After the first use of the product, do not insert/remove the SD memory card to/from the CPU module more than 500 times. Exceeding the limit may cause malfunction.
 - Do not touch the metal terminals on the back side of the SD memory card. Doing so may cause malfunction or failure.
 - Do not touch the integrated circuits on the circuit board of an extended SRAM cassette. Doing so may cause malfunction or failure of the module.
 - Do not drop or apply shock to the battery to be installed in the module. Doing so may damage the battery, causing the battery fluid to leak inside the battery. If the battery is dropped or any shock is applied to it, dispose of it without using.
 - Startup and maintenance of a control panel must be performed by qualified maintenance personnel with knowledge of protection against electric shock. Lock the control panel so that only qualified maintenance personnel can operate it.
 - Before handling the module, touch a conducting object such as a grounded metal to discharge the static electricity from the human body. Failure to do so may cause the module to fail or malfunction.
-

[Operating Precautions]

CAUTION

- When changing data and operating status, and modifying program of the running programmable controller from an external device such as a personal computer connected to an intelligent function module, read relevant manuals carefully and ensure the safety before operation. Incorrect change or modification may cause system malfunction, damage to the machines, or accidents.
 - Do not power off the programmable controller or reset the CPU module while the setting values in the buffer memory are being written to the flash ROM in the module. Doing so will make the data in the flash ROM undefined. The values need to be set in the buffer memory and written to the flash ROM again. Doing so can cause malfunction or failure of the module.
-

[Disposal Precautions]

CAUTION

- When disposing of this product, treat it as industrial waste.
 - When disposing of batteries, separate them from other wastes according to the local regulations. For details on battery regulations in EU member states, refer to the MELSEC iQ-R Module Configuration Manual.
-

[Transportation Precautions]

CAUTION

- When transporting lithium batteries, follow the transportation regulations. For details on the regulated models, refer to the MELSEC iQ-R Module Configuration Manual.
 - The halogens (such as fluorine, chlorine, bromine, and iodine), which are contained in a fumigant used for disinfection and pest control of wood packaging materials, may cause failure of the product. Prevent the entry of fumigant residues into the product or consider other methods (such as heat treatment) instead of fumigation. The disinfection and pest control measures must be applied to unprocessed raw wood.
-

CONDITIONS OF USE FOR THE PRODUCT

- (1) Mitsubishi programmable controller ("the PRODUCT") shall be used in conditions;
- i) where any problem, fault or failure occurring in the PRODUCT, if any, shall not lead to any major or serious accident; and
 - ii) where the backup and fail-safe function are systematically or automatically provided outside of the PRODUCT for the case of any problem, fault or failure occurring in the PRODUCT.
- (2) The PRODUCT has been designed and manufactured for the purpose of being used in general industries. MITSUBISHI SHALL HAVE NO RESPONSIBILITY OR LIABILITY (INCLUDING, BUT NOT LIMITED TO ANY AND ALL RESPONSIBILITY OR LIABILITY BASED ON CONTRACT, WARRANTY, TORT, PRODUCT LIABILITY) FOR ANY INJURY OR DEATH TO PERSONS OR LOSS OR DAMAGE TO PROPERTY CAUSED BY the PRODUCT THAT ARE OPERATED OR USED IN APPLICATION NOT INTENDED OR EXCLUDED BY INSTRUCTIONS, PRECAUTIONS, OR WARNING CONTAINED IN MITSUBISHI'S USER, INSTRUCTION AND/OR SAFETY MANUALS, TECHNICAL BULLETINS AND GUIDELINES FOR the PRODUCT.

("Prohibited Application")

Prohibited Applications include, but not limited to, the use of the PRODUCT in;

- Nuclear Power Plants and any other power plants operated by Power companies, and/or any other cases in which the public could be affected if any problem or fault occurs in the PRODUCT.
- Railway companies or Public service purposes, and/or any other cases in which establishment of a special quality assurance system is required by the Purchaser or End User.
- Aircraft or Aerospace, Medical applications, Train equipment, transport equipment such as Elevator and Escalator, Incineration and Fuel devices, Vehicles, Manned transportation, Equipment for Recreation and Amusement, and Safety devices, handling of Nuclear or Hazardous Materials or Chemicals, Mining and Drilling, and/or other applications where there is a significant risk of injury to the public or property.

Notwithstanding the above, restrictions Mitsubishi may in its sole discretion, authorize use of the PRODUCT in one or more of the Prohibited Applications, provided that the usage of the PRODUCT is limited only for the specific applications agreed to by Mitsubishi and provided further that no special quality assurance or fail-safe, redundant or other safety features which exceed the general specifications of the PRODUCTS are required. For details, please contact the Mitsubishi representative in your region.

INTRODUCTION

Thank you for purchasing the Mitsubishi MELSEC iQ-R series programmable controllers. This manual describes the specifications, procedures before operation, wiring, and programming of the relevant products listed below. Before using this product, please read this manual and the relevant manuals carefully and develop familiarity with the functions and performance of the MELSEC iQ-R series programmable controller to handle the product correctly. When applying the program examples provided in this manual to an actual system, ensure the applicability and confirm that it will not cause system control problems. Please make sure that the end users read this manual.



Unless otherwise specified, this manual provides program examples in which the I/O numbers of X/Y0 to X/YF are assigned to a temperature input module. Assign I/O numbers when applying the program examples to an actual system. For I/O number assignment, refer to the following.

MELSEC iQ-R Module Configuration Manual



Relevant products

R60TD8-G, R60RD8-G

COMPLIANCE WITH EMC AND LOW VOLTAGE DIRECTIVES

Method of ensuring compliance



To ensure that Mitsubishi programmable controllers maintain EMC and Low Voltage Directives when incorporated into other machinery or equipment, certain measures may be necessary. Please refer to one of the following manuals.

-  MELSEC iQ-R Module Configuration Manual
-  Safety Guidelines (This manual is included with the base unit.)

The CE mark on the side of the programmable controller indicates compliance with EMC and Low Voltage Directives.

Additional measures

To ensure that this product maintains EMC and Low Voltage Directives, please refer to one of the following manuals.

-  MELSEC iQ-R Module Configuration Manual
-  Safety Guidelines (This manual is included with the base unit.)

MEMO

CONTENTS

SAFETY PRECAUTIONS	1
CONDITIONS OF USE FOR THE PRODUCT	10
INTRODUCTION	10
COMPLIANCE WITH EMC AND LOW VOLTAGE DIRECTIVES	11
RELEVANT MANUALS	14
TERMS	14
CHAPTER 1 PART NAMES	15
CHAPTER 2 SPECIFICATIONS	17
2.1 Performance Specifications	17
CHAPTER 3 FUNCTION LIST	19
CHAPTER 4 PROCEDURES BEFORE OPERATION	21
CHAPTER 5 WIRING	23
5.1 Wiring Precautions	23
Connector for external devices	23
5.2 External Wiring	24
Signal layout of connectors for external devices	24
External wiring examples	26
To use a connector/terminal block converter module	29
CHAPTER 6 OPERATION EXAMPLES	31
6.1 Programming Procedure	31
6.2 Program Examples	31
CHAPTER 7 OFFSET/GAIN SETTING	37
7.1 Setting Procedure	37
APPENDICES	40
Appendix 1 Accuracy	40
Appendix 2 External Dimensions	43
INDEX	44
REVISIONS	46
WARRANTY	47
TRADEMARKS	48

RELEVANT MANUALS

Manual name [manual number]	Description	Available form
MELSEC iQ-R Channel Isolated Thermocouple Input Module/Channel Isolated RTD Input Module User's Manual (Startup) [SH-081493ENG] (this manual)	System configuration, specifications, procedures before operation, wiring, and operation examples of the channel isolated thermocouple input module and the channel isolated RTD input module	Print book e-Manual PDF
MELSEC iQ-R Channel Isolated Thermocouple Input Module/Channel Isolated RTD Input Module User's Manual (Application) [SH-081495ENG]	Functions, parameter settings, I/O signals, buffer memory, and troubleshooting of the channel isolated thermocouple input module and the channel isolated RTD input module	Print book e-Manual PDF
MELSEC iQ-R Programming Manual (Instructions, Standard Functions/Function Blocks) [SH-081266ENG]	Instructions for the CPU module, dedicated instructions for the intelligent function modules, and standard functions/function blocks	e-Manual PDF

This manual does not include detailed information on the following:

- General specifications
- Applicable CPU modules and the number of mountable modules
- Installation

For details, refer to the following.

 MELSEC iQ-R Module Configuration Manual

This manual does not include information on the module function blocks.

For details, refer to the Function Block Reference for the module used.

Point

e-Manual refers to the Mitsubishi FA electronic book manuals that can be browsed using a dedicated tool.

e-Manual has the following features:

- Required information can be cross-searched in multiple manuals.
- Other manuals can be accessed from the links in the manual.
- The hardware specifications of each part can be found from the product figures.
- Pages that users often browse can be bookmarked.

TERMS

Unless otherwise specified, this manual uses the following terms.

Term	Description
Engineering tool	A tool for programmable controller settings, programming, debug, and maintenance. For available tools, refer to the following.  MELSEC iQ-R Module Configuration Manual
Temperature input module	A generic term for the thermocouple input module and the RTD input module
Global label	A label that is valid for all the program data when multiple program data are created in the project. The global label has two types: a module specific label (module label), which is generated automatically by GX Works3, and an optional label, which can be created for any specified device.
RTD input module	The abbreviation for the MELSEC iQ-R series channel isolated RTD input module
Thermocouple input module	The abbreviation for the MELSEC iQ-R series channel isolated thermocouple input module
Module label	A label that represents one of memory areas (I/O signals and buffer memory areas) specific to each module in a given character string. For the module used, GX Works3 automatically generates this label, which can be used as a global label.
Cold junction compensation resistor (RTD)	The abbreviation for the resistance temperature detector (RTD) used for cold junction compensation

1 PART NAMES

This chapter describes the part names of temperature input modules.

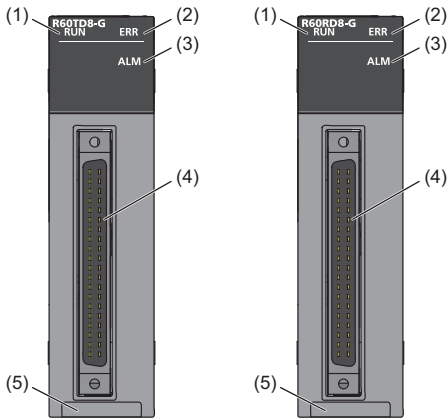

No.	Name	Description
(1)	RUN LED	Indicates the operating status of the module. On: Normal operation Flashing (1s cycle): In offset/gain setting mode Flashing (400ms cycle): The module for online module change selected Off: 5V power supply interrupted or watchdog timer error occurred, module change for online module change possible
(2)	ERR LED	Indicates the error status of the module. On: Error occurred*1 Off: Normal operation
(3)	ALM LED	Indicates the alarm status of the module. On: Alert (process alarm or rate alarm) issued Flashing: Disconnection detected Off: Normal operation
(4)	Connector for external devices	A connector for input signal wires of external devices and others For the signal layout, refer to the following. ☞ Page 24 Signal layout of connectors for external devices
(5)	Production information marking	Shows the product information (16 digits) of the module.

*1 For details, refer to the following.

📖 MELSEC iQ-R Channel Isolated Thermocouple Input Module/Channel Isolated RTD Input Module User's Manual (Application)

MEMO

2 SPECIFICATIONS

This chapter describes the performance specifications.

2.1 Performance Specifications

This section describes the performance specifications of temperature input modules.

Thermocouple input module

Item	Specifications	
Model	R60TD8-G	
Number of analog input channels	8 channels + Cold junction compensation channel per module	
Output	Measured temperature value	16-bit signed binary value (-2700 to 18200)
	Scaling value	16-bit signed binary value
Compliant thermocouple standard	JIS C1602-1995, IEC 60584-1(1995), IEC60584-2(1982)	
Usable thermocouples and conversion accuracy	For details, refer to the following. ☞ Page 40 Usable thermocouple, conversion accuracy, and effect per wiring resistance 1Ω	
Cold junction compensation accuracy	±1.0°C	
Accuracy*1	For details, refer to the following. ☞ Page 40 Accuracy of the thermocouple input module	
Resolution	B, R, S, N: 0.3°C K, E, J, T: 0.1°C	
Conversion speed*2	30ms/channel	
Isolation method*3	Between thermocouple input channel and programmable controller power supply	Transformer isolation
	Between thermocouple input channels	Transformer isolation
Withstand voltage	Between thermocouple input channel and programmable controller power supply	500VACrms for 1 minute
	Between thermocouple input channels	1000VACrms for 1 minute
Insulation resistance	Between thermocouple input channel and programmable controller power supply	500VDC 10MΩ or higher
	Between thermocouple input channels	500VDC 10MΩ or higher
Disconnection detection	Built-in	
Number of offset/gain settings*4	50000 times maximum	
Number of occupied I/O points	16 points (I/O assignment: Intelligent 16 points)	
External interface	40-pin connector	
Applicable wire size	When A6CON1 and A6CON4 are used	0.088 to 0.3mm ² (28 to 22 AWG) (stranded wire)
	When A6CON2 is used	0.088 to 0.24mm ² (28 to 24 AWG) (stranded wire)
Connector for external devices	A6CON1, A6CON2, A6CON4 (sold separately)	
Internal current consumption (5VDC)	0.36A	
External dimensions	Height	106mm
	Width	27.8mm
	Depth	110mm
Weight	0.19kg	

*1 Except for the conditions under noise influence.

*2 This conversion speed is the time required to store a measured temperature value into the buffer memory in sampling processing.

*3 No isolation is provided between the cold junction compensation channel and the programmable controller power supply.

*4 A count more than 50000 times causes Number of writes to offset/gain settings reach limit error (error code: 1080H).

RTD input module

Item		Specifications	
Model		R60RD8-G	
Number of analog input channels		8 channels	
Output	Measured temperature value	16-bit signed binary value (-2000 to 8500)	
	Scaling value	16-bit signed binary value	
Usable resistance temperature detector* ¹		Pt100 (JIS C 1604-2013, IEC 751:1983) JPt100 (JIS C 1604-1981) Ni100 (DIN 43760 1987) Pt50 (JIS C 1604-1981)	
Temperature measuring range	Pt100	-200 to 850°C	
	JPt100	-180 to 600°C	
	Ni100	-60 to 250°C	
	Pt50	-200 to 650°C	
Output current for temperature detection		1.0mA or lower	
Conversion accuracy* ^{2,3}	Pt100	-200 to 850°C	±0.8°C (ambient temperature: 25±5°C), ±2.4°C (ambient temperature: 0 to 55°C)
		-20 to 120°C	±0.3°C (ambient temperature: 25±5°C), ±1.1°C (ambient temperature: 0 to 55°C)
		0 to 200°C	±0.4°C (ambient temperature: 25±5°C), ±1.2°C (ambient temperature: 0 to 55°C)
	JPt100	-180 to 600°C	±0.8°C (ambient temperature: 25±5°C), ±2.4°C (ambient temperature: 0 to 55°C)
		-20 to 120°C	±0.3°C (ambient temperature: 25±5°C), ±1.1°C (ambient temperature: 0 to 55°C)
		0 to 200°C	±0.4°C (ambient temperature: 25±5°C), ±1.2°C (ambient temperature: 0 to 55°C)
	Ni100	-60 to 250°C	±0.4°C (ambient temperature: 25±5°C), ±1.2°C (ambient temperature: 0 to 55°C)
	Pt50	-200 to 650°C	±0.8°C (ambient temperature: 25±5°C), ±2.4°C (ambient temperature: 0 to 55°C)
Resolution		0.1°C	
Conversion speed* ⁴		10ms/channel	
Isolation method	Between RTD input channel and programmable controller power supply	Transformer isolation	
	Between RTD input channels	Transformer isolation	
Withstand voltage	Between RTD input channel and programmable controller power supply	500VACrms for 1 minute	
	Between RTD input channels	1000VACrms for 1 minute	
Insulation resistance	Between RTD input channel and programmable controller power supply	500VDC 10MΩ or higher	
	Between RTD input channels	500VDC 10MΩ or higher	
Disconnection detection		Built-in	
Number of offset/gain settings* ⁵		50000 times maximum	
Number of occupied I/O points		16 points (I/O assignment: Intelligent 16 points)	
External interface		40-pin connector	
Applicable wire size	When A6CON1 and A6CON4 are used	0.088mm ² to 0.3mm ² (28 to 22 AWG) (stranded wire)	
	When A6CON2 is used	0.088mm ² to 0.24mm ² (28 to 24 AWG) (stranded wire)	
Connector for external devices		A6CON1, A6CON2, A6CON4 (sold separately)	
Internal current consumption (5VDC)		0.35A	
External dimensions	Height	106mm	
	Width	27.8mm	
	Depth	110mm	
Weight		0.19kg	

*1 An usable resistance temperature detector is 3-wire type only. A resistance temperature detector of 2-wire type or 4-wire type cannot be used.

*2 When a value outside the input range is input from a resistance temperature detector, the value is regarded as the maximum value or minimum value of the input range.

*3 The accuracy when a resistance temperature detector is connected, refer to the following.

☞ Page 42 Accuracy of the RTD input module

*4 This conversion speed is the time required to store a measured temperature value into the buffer memory in sampling processing.

*5 A count more than 50000 times causes Number of writes to offset/gain settings reach limit error (error code: 1080H).

3 FUNCTION LIST

This chapter lists the functions of temperature input modules. For details on the functions, refer to the following.

📖 MELSEC iQ-R Channel Isolated Thermocouple Input Module/Channel Isolated RTD Input Module User's Manual (Application)

Item		Description	
Input range setting function		Allows to select the thermocouple type or resistance temperature detector type to be used as well as the input range for each channel.	
Conversion enable/disable setting function		Sets whether to enable or disable the temperature conversion for each channel. Disabling the conversion on unused channels reduces the conversion cycles.	
Temperature conversion method	Sampling processing	Executes the conversion of temperature input values every sampling cycle and stores the converted values in buffer memory areas as measured temperature values.	
	Averaging processing	Time average	Executes the temperature conversion for set time and averages the total value excluding the maximum value and the minimum value. The calculated value is stored in the buffer memory area. The number of processing times within the set time varies depending on the number of channels where the conversion is enabled.
		Count average	Executes the temperature conversion for a set number of times and averages the total value excluding the maximum value and the minimum value. The calculated value is stored in the buffer memory area. The time taken to store the average value obtained by the processing in the buffer memory area varies depending on the number of channels where the conversion is enabled.
		Moving average	Averages measured temperature values taken at every sampling cycle for a specified number of times, and stores the averaged value in the buffer memory area. Because the target range for averaging processing is moved in response to every sampling processing, the latest measured temperature value can be obtained.
Primary delay filter		Performs the conversion where the transient noise of temperature input is smoothed depending on the set time constant. The smoothed measured temperature value is stored in the buffer memory area.	
Scaling function		Performs scale conversion from a measured temperature value to a value calculated using the ratio (%) of the set scaling width to the set scaling range. The converted value is stored in the buffer memory area.	
Alert output function	Process alarm	Outputs an alert when a measured temperature value enters the preset alert output range.	
	Rate alarm	Outputs an alert when the change of a measured temperature value is equal to or greater than the rate alarm upper limit value, or equal to or smaller than the rate alarm lower limit value.	
Disconnection detection function		Outputs an alarm when disconnection of a thermocouple, compensation lead wire, or resistance temperature detector is detected. A measured temperature value to be stored at the disconnection detection is selected from the following. <ul style="list-style-type: none"> • Value just before disconnection • Upscale • Downscale • Any value 	
Cold junction compensation setting function		Enables two types of cold junction compensation (using a cold junction compensation resistor or an external method (cooling bath)) by setting whether to use a cold junction compensation resistor.	
Cold junction compensation resistor disconnection detection function		Outputs an error when disconnection of a cold junction compensation resistor (RTD) is detected.	
Logging function		Logs (records) measured temperature values or scaling values. Data of 1000 points can be logged for each channel.	
Logging read function		Allows to store more than 1000 points of data without stopping logging by transferring the device data to the file register of the CPU module during logging. This function reduces the takt time in a test demanding high-speed conversion.	
Interrupt function		Executes an interrupt program of the CPU module when an interrupt factor such as alert output or disconnection is detected.	
Error history function		Records up to 16 errors and alarms that occurred in a temperature input module to store them in the buffer memory areas.	
Event history function		Collects occurred errors and alarms, and performed operations in a temperature input module, and stores them as event information into the CPU module.	
Offset/gain setting		Corrects errors in measured temperature values.	
Backing up, saving, and restoring offset/gain values		Allows to back up, save, and restore the offset/gain values of the user range setting.	

Item	Description
Online module change	Allows to replace a module without stopping the system. For procedures for the online module change, refer to the following.  MELSEC iQ-R Online Module Change Manual
Q compatible mode function	Allows to convert the layout of buffer memory addresses of a temperature input module to the one equivalent to a MELSEC-Q series module. This compatibility enables the reuse of programs that have proven performance on MELSEC-Q series modules.

4 PROCEDURES BEFORE OPERATION

This chapter describes the procedures before operation.

1. Mounting a module

Mount a temperature input module in any desired configuration.

2. Wiring

Perform wiring of thermocouples or resistance temperature detectors to a temperature input module.

3. Adding a module

Add a temperature input module to a module configuration by using the engineering tool. For details, refer to the following.

 GX Works3 Operating Manual

4. Module settings

Set up the parameters of the temperature input module by using the engineering tool. For details, refer to the following.

 MELSEC iQ-R Channel Isolated Thermocouple Input Module/Channel Isolated RTD Input Module User's Manual (Application)

5. Offset/gain setting

Perform the offset/gain setting to set a user range.

 Page 37 OFFSET/GAIN SETTING

6. Programming

Create a program. For details, refer to the following.

 Page 31 OPERATION EXAMPLES

MEMO

5 WIRING

This chapter describes the wiring of a temperature input module.

5.1 Wiring Precautions

Check the signal layout and then correctly wire a temperature input module. For the signal layout, refer to the following.

 Page 24 Signal layout of connectors for external devices

Connector for external devices

Precautions

- Tighten the connector screws within the specified torque range.

Screw type	Tightening torque range
Connector screw (M2.6)	0.20 to 0.29N·m

- Use copper wire with a temperature rating of 75°C or higher for the connector.
- Use UL listed connectors if necessary for UL compliance.

Applicable connectors

Connectors for external devices to be used for a temperature input module are sold separately.

The following tables list the applicable connectors, and the reference product of a crimping tool.

■40-pin connectors

Type	Model	Applicable wire size
Soldering type connector (straight type)	A6CON1	0.088 to 0.3mm ² (28 to 22 AWG) (stranded wire)
Crimping type connector (straight type)	A6CON2	0.088 to 0.24mm ² (28 to 24 AWG) (stranded wire)
Soldering type connector (dual purpose (straight/oblique) type)	A6CON4	0.088 to 0.3mm ² (28 to 22 AWG) (stranded wire)

*1 Use a cable with a sheath outside diameter of 1.3mm or less when 40 cables are connected.
Select appropriate cables according to the current value used.

Point

- The A6CON3 (IDC type connector (straight type)) cannot be used.
- A connector/terminal block converter module for MELSEC-Q series temperature input module and the dedicated cable can be used. For details, refer to the following.

 Page 29 To use a connector/terminal block converter module

■40-pin connector crimping tool

Type	Model	Contact
Crimping tool	FCN-363T-T005/H	FUJITSU COMPONENT LIMITED

For how to wire the connector and how to use the crimping tool, contact the manufacturer.

Wiring methods, and installation and removal procedures for the connectors

For the wiring methods, and installation and removal procedures, refer to the following.

 MELSEC iQ-R Module Configuration Manual

5.2 External Wiring

Signal layout of connectors for external devices

The following tables show the signal layout of external device connectors of a temperature input module.

Thermocouple input module

Pin layout (viewed from the front of the module)	CH1 to CH8, RTD			
	Pin number	Signal name	Pin number	Signal name
A1	□ □	B1	A1	CH1+
A2	□ □	B2	B1	CH1-
A3	□ □	B3	A2	—
A4	□ □	B4	B2	—
A5	□ □	B5	A3	CH2+
A6	□ □	B6	B3	CH2-
A7	□ □	B7	A4	—
A8	□ □	B8	B4	—
A9	□ □	B9	A5	CH3+
A10	□ □	B10	B5	CH3-
A11	□ □	B11	A6	—
A12	□ □	B12	B6	—
A13	□ □	B13	A7	CH4+
A14	□ □	B14	B7	CH4-
A15	□ □	B15	A8	—
A16	□ □	B16	B8	—
A17	□ □	B17	A9	CH5+
A18	□ □	B18	B9	CH5-
A19	□ □	B19	A10	—
A20	□ □	B20	B10	—
			A11	CH6+
			B11	CH6-
			A12	—
			B12	—
			A13	CH7+
			B13	CH7-
			A14	—
			B14	—
			A15	CH8+
			B15	CH8-
			A16	—
			B16	—
			A17	—
			B17	—
			A18	—
			B18	—
			A19	—
			B19	RTD+
			A20	RTDG
			B20	RTD-

RTD input module

Pin layout (viewed from the front of the module)	CH1 to CH8					
	Pin number	Signal name	Pin number	Signal name		
A1	□ □	B1	A1	CH1 A1	B1	CH1 B1
A2	□ □	B2	A2	CH1 b1	B2	—
A3	□ □	B3	A3	—	B3	CH2 b2
A4	□ □	B4	A4	CH2 A2	B4	CH2 B2
A5	□ □	B5	A5	—	B5	—
A6	□ □	B6	A6	CH3 A3	B6	CH3 B3
A7	□ □	B7	A7	CH3 b3	B7	—
A8	□ □	B8	A8	—	B8	CH4 b4
A9	□ □	B9	A9	CH4 A4	B9	CH4 B4
A10	□ □	B10	A10	—	B10	—
A11	□ □	B11	A11	CH5 A5	B11	CH5 B5
A12	□ □	B12	A12	CH5 b5	B12	—
A13	□ □	B13	A13	—	B13	CH6 b6
A14	□ □	B14	A14	CH6 A6	B14	CH6 B6
A15	□ □	B15	A15	—	B15	—
A16	□ □	B16	A16	CH7 A7	B16	CH7 B7
A17	□ □	B17	A17	CH7 b7	B17	—
A18	□ □	B18	A18	—	B18	CH8 b8
A19	□ □	B19	A19	CH8 A8	B19	CH8 B8
A20	□ □	B20	A20	—	B20	—

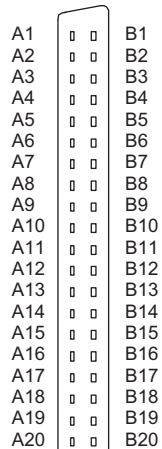

External wiring examples

This section shows the examples of external wiring.

Thermocouple input module

Follow the procedure below for wiring.

1. Install a relay terminal block.
2. Connect thermocouples and compensation lead wires to the relay terminal block.
3. When With cold junction compensation (0) is set to 'Cold junction compensation with/without setting' (Un\G298), connect the provided cold junction compensation resistor (RTD) to the relay terminal block.
4. Wire the relay terminal block to a thermocouple input module using an external device connector.

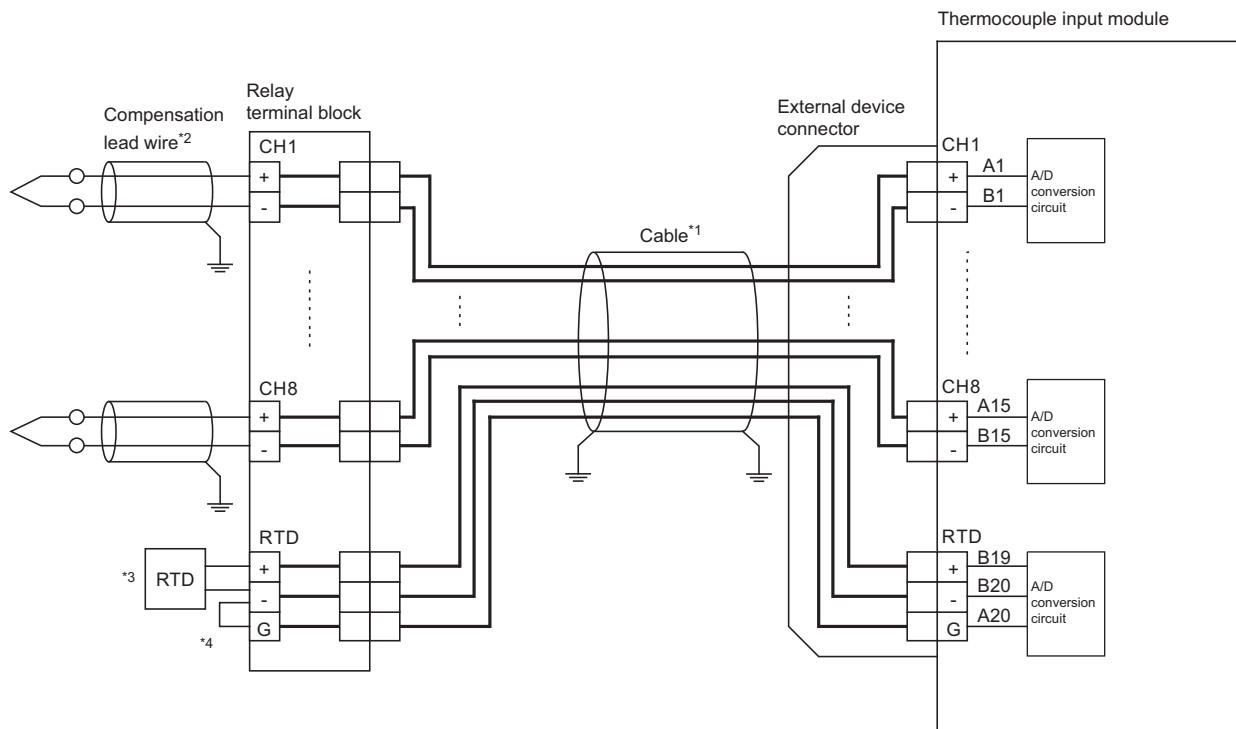

*1 Use a shielded cable and ground the shields. Do not use a compensation lead wire.

*2 Use a shielded compensation lead wire and ground the shield. Do not use a cable.

*3 Connect the cold junction compensation resistor (RTD) when With cold junction compensation (0) is set to 'Cold junction compensation with/without setting' (Un\G298).

*4 When connect the cold junction compensation resistor (RTD), connect the terminal of RTD- to the terminal of RTDG.

If the cold junction compensation resistor (RTD) and the reference junction of the thermocouple (or the reference junction of the compensation lead wire) are not connected to the same place (relay terminal block), the (ambient) temperature difference may lead to a faulty measured temperature value. In addition, if an incorrect wire is connected between A and B or B and C (case 1 or case 2 below), the (ambient) temperature difference may lead to a faulty measured temperature value.

- Case 1 (a cable is connected between the reference junction of the thermocouple and the relay terminal block)

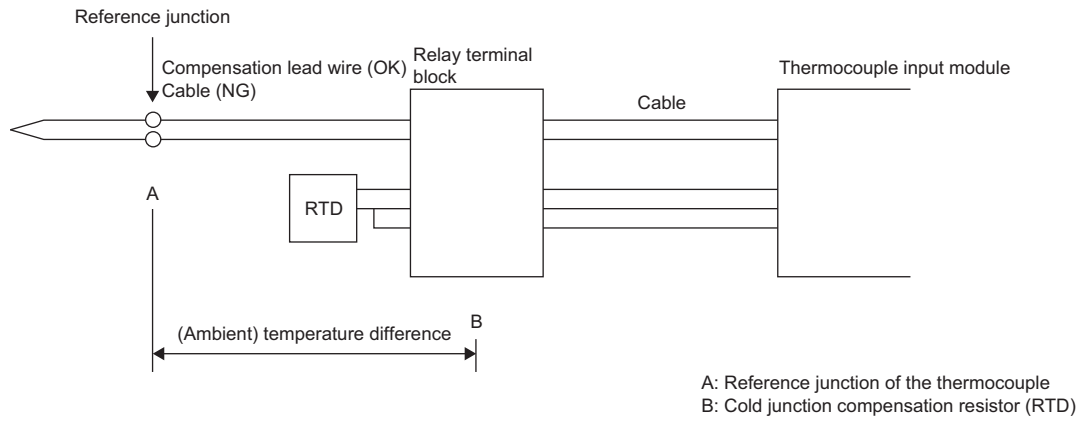

- Case 2 (a compensation lead wire is connected between the relay terminal block and the thermocouple input module)

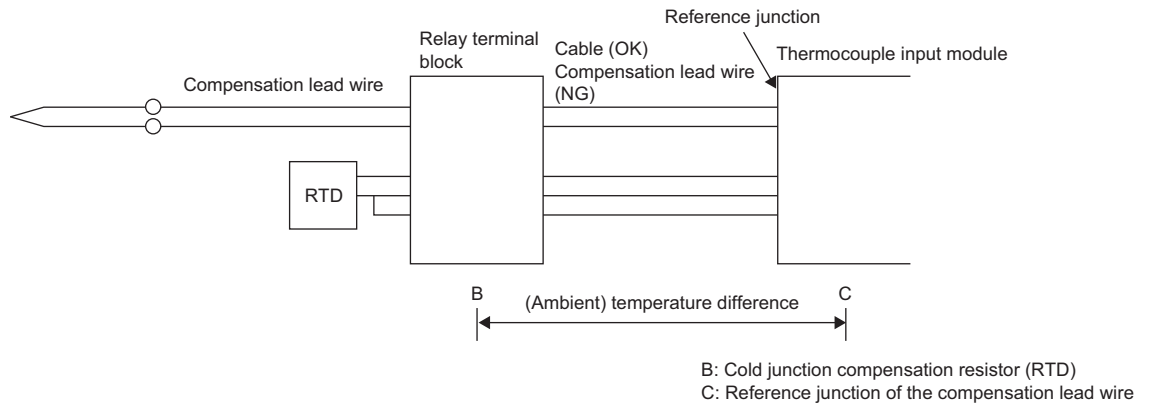

RTD input module

Follow the procedure below for wiring.

1. Install a relay terminal block.
2. Connect resistance temperature detectors to the relay terminal block.
3. Wire the relay terminal block to a RTD input module using an external device connector.

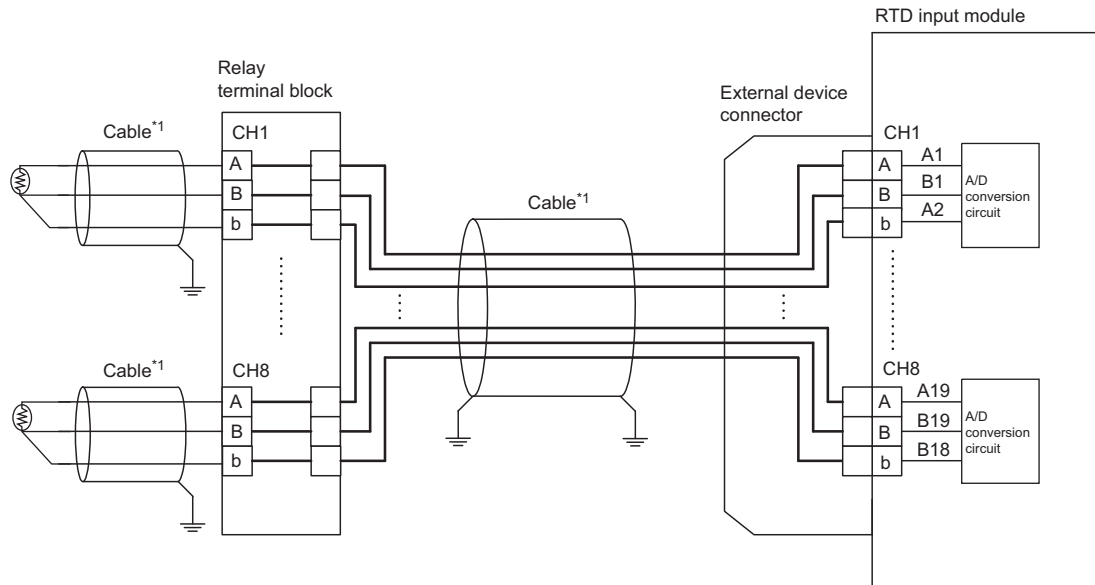

*1 Use a shielded cable and ground the shields.

■ Specifications when a resistance temperature detector is connected

When connecting a resistance temperature detector to the RTD input module, make sure that the conductor resistance values of three wires satisfy the conditions below.

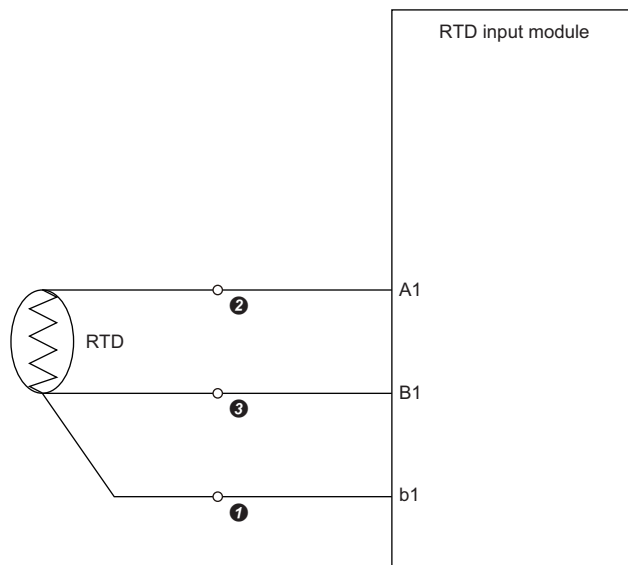

- Each conductor resistance of ①, ②, and ③ must be 350Ω or lower.
- The difference of conductor resistance values between ② and ③ must be 10Ω or lower when Pt100, JPt100, or Ni100 is used, 5Ω or lower when Pt50 is used.

To use a connector/terminal block converter module

A connector/terminal block converter module for MELSEC-Q series temperature input module can be used with a temperature input module. This section shows the examples of external wiring when a connector/terminal block converter module is used.

Thermocouple input module

Use the connector/terminal block converter module for the Q68TD-G-H02(H01). Wire the modules as shown below.

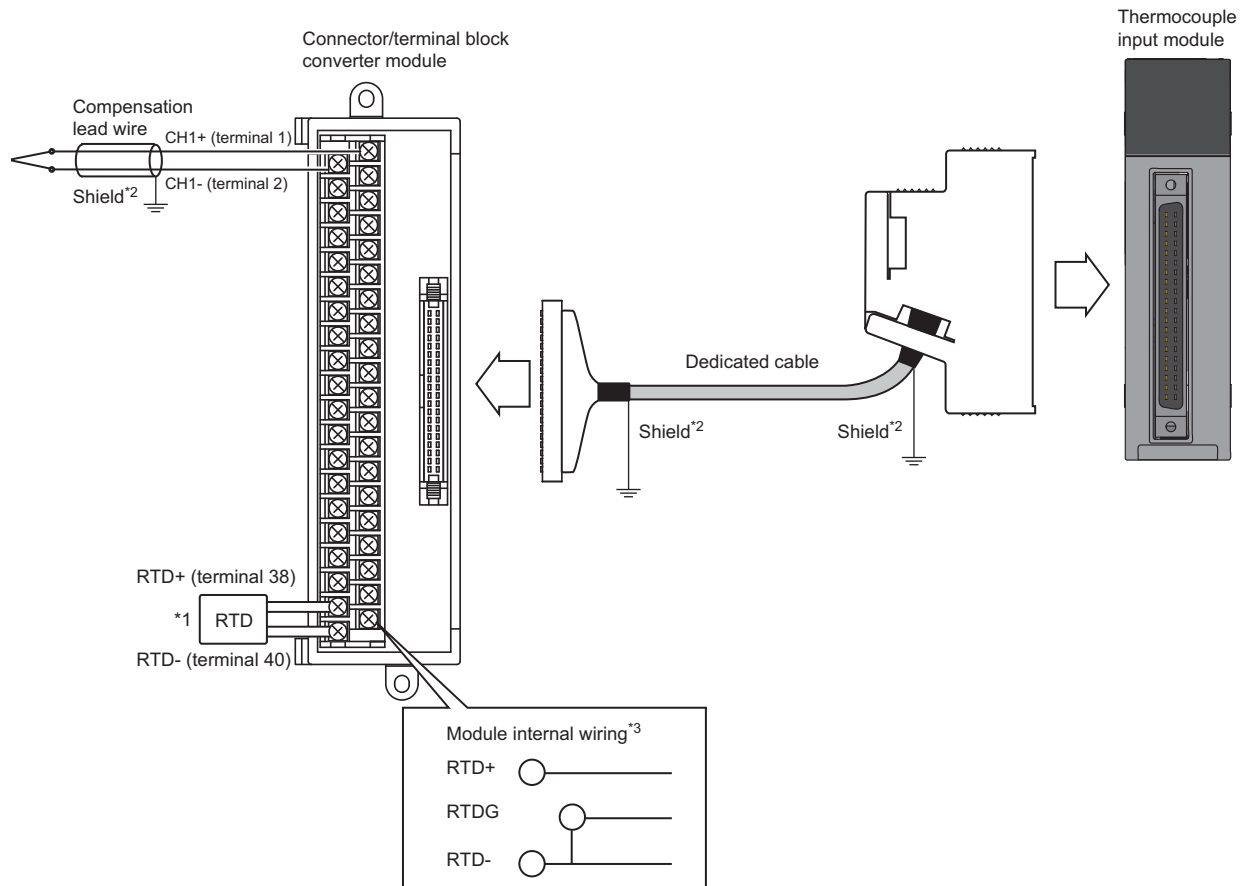

*1 Connect the cold junction compensation resistor (RTD) when With cold junction compensation (0) is set to 'Cold junction compensation with/without setting' (Un\G298).

*2 Ground the shields.

*3 The RTD- and RTDG are connected in the connector/terminal block converter module. Therefore the connection of RTD- and RTDG at the terminal block is not required.

Product name	Model	Remarks	Contact
Connector/terminal block converter module	FA-LTB40TDG	—	Your local Mitsubishi Electric sales office or representative
Dedicated cable	FA-CBL05Q68TDG	Cable length: 0.5m	
	FA-CBL10Q68TDG	Cable length: 1.0m	
	FA-CBL20Q68TDG	Cable length: 2.0m	
	FA-CBL30Q68TDG	Cable length: 3.0m	

RTD input module

Use the connector/terminal block converter module for the Q68RD3-G. Wire the modules as shown below.

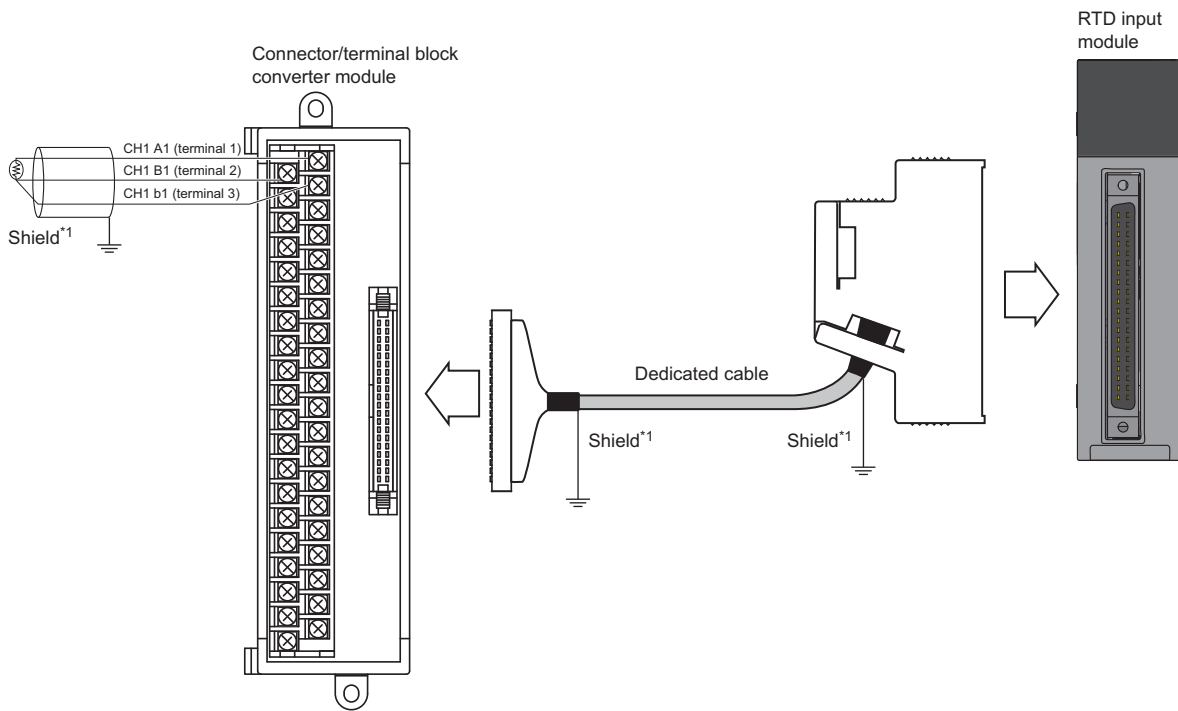

*1 Ground the shields.

Product name	Model	Remarks	Contact
Connector/terminal block converter module	FA-LTB40RD3G	—	Your local Mitsubishi Electric sales office or representative
Dedicated cable	FA-CBL05Q68RD3G	Cable length: 0.5m	
	FA-CBL10Q68RD3G	Cable length: 1.0m	
	FA-CBL20Q68RD3G	Cable length: 2.0m	
	FA-CBL30Q68RD3G	Cable length: 3.0m	

6 OPERATION EXAMPLES

This chapter describes the programming procedure and the basic program of a temperature input module.

6.1 Programming Procedure

Take the following steps to create a program for running a temperature input module:

1. Set parameters.

☞ Page 32 Parameter settings

2. Create a program.

☞ Page 35 Program examples

6.2 Program Examples

System configuration

The following figure shows an example of the system configuration.

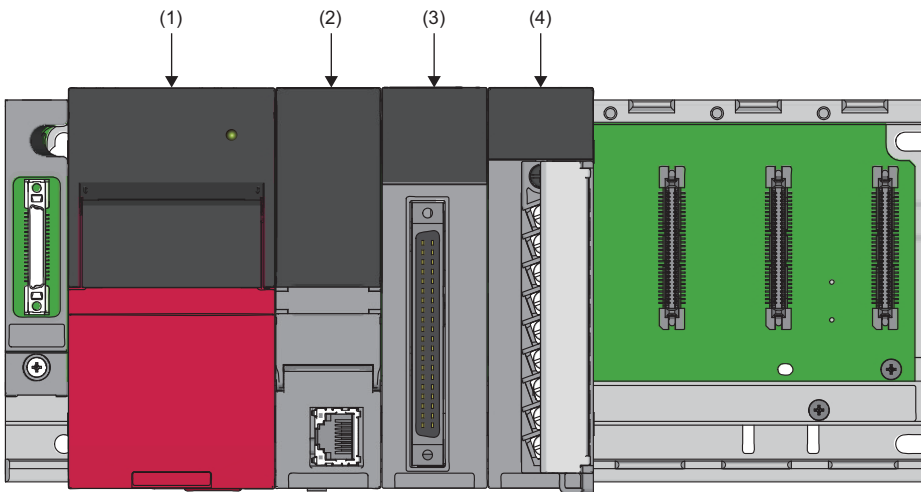

(1) Power supply module (R61P)

(2) CPU module (R120CPU)

(3) Temperature input module (R60TD8-G)

(4) Input module (RX10)

Parameter settings

Perform an initial setting in the module parameter of the engineering tool. The refresh settings do not need to be changed here.

For details on the module parameter, refer to the following.

📖 MELSEC iQ-R Channel Isolated Thermocouple Input Module/Channel Isolated RTD Input Module User's Manual (Application)

■ Basic setting

Configure the basic setting as shown below.

The screenshot displays the '0000:R60TD8-G Module Parameter' software interface. On the left, the 'Setting Item List' includes: Basic setting, Application setting, Interrupt setting, and Refresh settings. The main 'Setting Item' area contains a table with the following data:

Item	CH1	CH2	CH3	CH4	CH5	CH6	CH7	CH8
Thermocouple type selection function	Set the thermocouple type for each channel.							
Thermocouple type setting	Thermocouple K	Thermocouple K	Thermocouple E	Thermocouple K	Thermocouple J	Thermocouple K	Thermocouple T	Thermocouple K
Offset/gain setting	Factory default ; Factory default ; Factory default ; Factory default ; User range sett; Factory default ; User range sett; Factory default setting							
Cold junction temperature compensation with/without setting function	Set the cold junction temperature compensation with/without using the cold junction temperature compensation resistor.							
Cold junction temperature compensation with/without setting	With cold junction temperature compensation							
Operation mode setting function	The two operation modes, "Normal mode" to execute the normal temperature conversion and "Offset/gain setting mode" to execute th							
Operation mode setting	Normal mode (Conversion process)							
Conversion enable/disable setting function	Set whether to enable or disable the output of the conversion value.							
Conversion enable/disable setting	Conversion enab	Conversion disat	Conversion enab	Conversion disat	Conversion enab	Conversion disat	Conversion enab	Conversion disable
Temperature conversion system	Set the temperature conversion control system.							
Average processing setting	Sampling proces	Sampling proces	Count average	Sampling proces	Moving average	Sampling proces	Sampling proces	Sampling processing
Time average/Count average/Moving average/Primary delay filter constant setting	0	0	50 times	0	10 times	0	0	0

Below the table, the 'Explanation' section states: 'Set the thermocouple type for each channel.'

Application setting

Configure the application setting as shown below.

0000:R60TD8-G Module Parameter

Setting Item List Setting Item

Input the Setting Item to Search

Item	CH1	CH2	CH3	CH4	CH5	CH6	CH7	CH8
Scaling function								
Configure the setting for the scaling at the conversion.								
Scaling enable/disable setting	Disable	Disable	Disable	Disable	Enable	Disable	Disable	Disable
Scaling range upper limit value	0.0 °C	0.0 °C	0.0 °C	0.0 °C	500.0 °C	0.0 °C	0.0 °C	0.0 °C
Scaling range lower limit value	0.0 °C	0.0 °C	0.0 °C	0.0 °C	-100.0 °C	0.0 °C	0.0 °C	0.0 °C
Scaling width upper limit value	0	0	0	0	100	0	0	0
Scaling width lower limit value	0	0	0	0	0	0	0	0
Warning output function (Process alarm)								
Set an alert at the conversion.								
Warning output setting (Process alarm)	Disable	Disable	Enable	Disable	Disable	Disable	Disable	Disable
Process alarm upper upper limit value	1200.0 °C	1200.0 °C	900.0 °C	1200.0 °C	1200.0 °C	1200.0 °C	1200.0 °C	1200.0 °C
Process alarm upper lower limit value	1200.0 °C	1200.0 °C	700.0 °C	1200.0 °C	1200.0 °C	1200.0 °C	1200.0 °C	1200.0 °C
Process alarm lower upper limit value	1200.0 °C	1200.0 °C	400.0 °C	1200.0 °C	1200.0 °C	1200.0 °C	1200.0 °C	1200.0 °C
Process alarm lower lower limit value	1200.0 °C	1200.0 °C	0.0 °C	1200.0 °C	1200.0 °C	1200.0 °C	1200.0 °C	1200.0 °C
Warning output function (Rate alarm)								
Set an alert at the conversion.								
Warning output setting (Rate alarm)	Enable	Disable	Disable	Disable	Disable	Disable	Disable	Disable
Rate alarm detection cycle setting	40 times	0 times	0 times	0 times	0 times	0 times	0 times	0 times
Rate alarm upper limit value	25.0 °C	0.0 °C	0.0 °C	0.0 °C	0.0 °C	0.0 °C	0.0 °C	0.0 °C
Rate alarm lower limit value	-5.0 °C	0.0 °C	0.0 °C	0.0 °C	0.0 °C	0.0 °C	0.0 °C	0.0 °C
Disconnection detection function								
Configure the setting for the disconnection detection at the conversion.								
Disconnection detection function enable/disable setting	Disable	Disable	Disable	Disable	Disable	Disable	Enable	Disable
Conversion setting for disconnection detection	Down Scale	Down Scale	Down Scale	Down Scale	Down Scale	Down Scale	Down Scale	Down Scale
Conversion setting value for disconnection detection	0.0 °C	0.0 °C	0.0 °C	0.0 °C	0.0 °C	0.0 °C	0.0 °C	0.0 °C
Disconnection detection. Automatic clear enable/disable setting	Disable							
Logging function								
Configure the setting for the logging function at the conversion.								
Logging enable/disable setting	Disable	Disable	Disable	Disable	Disable	Disable	Disable	Disable
Logging data setting	Measured temper	Measured temper	Measured temper	Measured temper	Measured temper	Measured temper	Measured temper	Measured temperature
Logging cycle setting value	240 ms	240 ms	240 ms	240 ms	240 ms	240 ms	240 ms	240 ms
Logging cycle unit setting	ms	ms	ms	ms	ms	ms	ms	ms
Level trigger condition setting	Disable	Disable	Disable	Disable	Disable	Disable	Disable	Disable
Logging points after trigger	500	500	500	500	500	500	500	500
Trigger data	400	600	800	1000	1200	1400	1600	1800
Trigger setting value	0	0	0	0	0	0	0	0
Logging loading enable/disable setting	Disable	Disable	Disable	Disable	Disable	Disable	Disable	Disable
Logging read points setting value	100	100	100	100	100	100	100	100
Online module change								
The module can be changed without the system being stopped.								
Auto restore of Offset/ gain setting with the module change	Enable							

Explanation

Configure the setting for the scaling at the conversion.

Item List Find Result Check Restore the Default Settings

Label settings

GX Works3 provides functions that support the creation of a program.

The following table lists the module labels and global labels used for the program examples in this section.

There is no need to change the settings of the module labels. For details on the global labels, refer to the following.

 MELSEC iQ-R Programming Manual (Program Design)

Classification	Label name	Description	Device																																																																																										
Module label	R60TDG_1.bModuleREADY	Module READY	X0																																																																																										
	R60TDG_1.bDisconnectionDetectionSignal	Disconnection detection signal	XC																																																																																										
	R60TDG_1.bConversionCompletedFlag	Conversion completed flag	XE																																																																																										
	R60TDG_1.bErrorFlag	Error flag	XF																																																																																										
	R60TDG_1.bOperatingConditionSettingRequest	Operating condition setting request	Y9																																																																																										
	R60TDG_1.stnMonitor[0].wMeasuredTemperatureValue	CH1 Measured temperature value	—																																																																																										
	R60TDG_1.uConversionCompletedFlag.0	CH1 Conversion completed flag	—																																																																																										
	R60TDG_1.stnMonitor[2].wMeasuredTemperatureValue	CH3 Measured temperature value	—																																																																																										
	R60TDG_1.uConversionCompletedFlag.2	CH3 Conversion completed flag	—																																																																																										
	R60TDG_1.stnMonitor[4].wMeasuredTemperatureValue	CH5 Measured temperature value	—																																																																																										
	R60TDG_1.uConversionCompletedFlag.4	CH5 Conversion completed flag	—																																																																																										
	R60TDG_1.stnMonitor[6].wMeasuredTemperatureValue	CH7 Measured temperature value	—																																																																																										
	R60TDG_1.uConversionCompletedFlag.6	CH7 Conversion completed flag	—																																																																																										
	R60TDG_1.uWarningOutputFlagProcessAlarmUpperLimit.2	CH3 Alert output flag (Process alarm upper limit)	—																																																																																										
	R60TDG_1.uWarningOutputFlagProcessAlarmLowerLimit.2	CH3 Alert output flag (Process alarm lower limit)	—																																																																																										
	R60TDG_1.uWarningOutputFlagRateAlarmUpperLimit.0	CH1 Alert output flag (Rate alarm upper limit)	—																																																																																										
	R60TDG_1.uWarningOutputFlagRateAlarmLowerLimit.0	CH1 Alert output flag (Rate alarm lower limit)	—																																																																																										
R60TDG_1.uDisconnectionDetectionFlag.6	CH7 Disconnection detection signal	—																																																																																											
Labels to be defined	Define global labels as shown below:																																																																																												
	<table border="1"> <thead> <tr> <th></th> <th>Label Name</th> <th>Data Type</th> <th>Class</th> <th>Assign (Device/Label)</th> </tr> </thead> <tbody> <tr><td>1</td><td>CH1_temperatureVal</td><td>Word [Signed]</td><td>... VAR_GLOBAL</td><td>▼ D11</td></tr> <tr><td>2</td><td>CH3_temperatureVal</td><td>Word [Signed]</td><td>... VAR_GLOBAL</td><td>▼ D12</td></tr> <tr><td>3</td><td>CH5_ScalingVal</td><td>Word [Signed]</td><td>... VAR_GLOBAL</td><td>▼ D13</td></tr> <tr><td>4</td><td>CH7_temperatureVal</td><td>Word [Signed]</td><td>... VAR_GLOBAL</td><td>▼ D14</td></tr> <tr><td>5</td><td>CH3_ProcAlmUpLimit</td><td>Bit</td><td>... VAR_GLOBAL</td><td>▼ F0</td></tr> <tr><td>6</td><td>CH3_ProcAlmLowLimit</td><td>Bit</td><td>... VAR_GLOBAL</td><td>▼ F1</td></tr> <tr><td>7</td><td>CH1_RateAlmUpLimit</td><td>Bit</td><td>... VAR_GLOBAL</td><td>▼ F2</td></tr> <tr><td>8</td><td>CH1_RateAlmLowLimit</td><td>Bit</td><td>... VAR_GLOBAL</td><td>▼ F3</td></tr> <tr><td>9</td><td>CH7disconnection</td><td>Bit</td><td>... VAR_GLOBAL</td><td>▼ F4</td></tr> <tr><td>10</td><td>DigitOutValSig</td><td>Bit</td><td>... VAR_GLOBAL</td><td>▼ X10</td></tr> <tr><td>11</td><td>ErrResetSig</td><td>Bit</td><td>... VAR_GLOBAL</td><td>▼ X13</td></tr> <tr><td>12</td><td>ErrOperationEN</td><td>Bit</td><td>... VAR_GLOBAL</td><td>▼</td></tr> <tr><td>13</td><td>ErrOperationENO</td><td>Bit</td><td>... VAR_GLOBAL</td><td>▼</td></tr> <tr><td>14</td><td>ErrOperationOK</td><td>Bit</td><td>... VAR_GLOBAL</td><td>▼</td></tr> <tr><td>15</td><td>UnitErrFlg</td><td>Bit</td><td>... VAR_GLOBAL</td><td>▼</td></tr> <tr><td>16</td><td>UnitErrCode</td><td>Word [Signed]</td><td>... VAR_GLOBAL</td><td>▼</td></tr> <tr><td>17</td><td>UnitAlarmCode</td><td>Word [Signed]</td><td>... VAR_GLOBAL</td><td>▼</td></tr> </tbody> </table>		Label Name	Data Type	Class	Assign (Device/Label)	1	CH1_temperatureVal	Word [Signed]	... VAR_GLOBAL	▼ D11	2	CH3_temperatureVal	Word [Signed]	... VAR_GLOBAL	▼ D12	3	CH5_ScalingVal	Word [Signed]	... VAR_GLOBAL	▼ D13	4	CH7_temperatureVal	Word [Signed]	... VAR_GLOBAL	▼ D14	5	CH3_ProcAlmUpLimit	Bit	... VAR_GLOBAL	▼ F0	6	CH3_ProcAlmLowLimit	Bit	... VAR_GLOBAL	▼ F1	7	CH1_RateAlmUpLimit	Bit	... VAR_GLOBAL	▼ F2	8	CH1_RateAlmLowLimit	Bit	... VAR_GLOBAL	▼ F3	9	CH7disconnection	Bit	... VAR_GLOBAL	▼ F4	10	DigitOutValSig	Bit	... VAR_GLOBAL	▼ X10	11	ErrResetSig	Bit	... VAR_GLOBAL	▼ X13	12	ErrOperationEN	Bit	... VAR_GLOBAL	▼	13	ErrOperationENO	Bit	... VAR_GLOBAL	▼	14	ErrOperationOK	Bit	... VAR_GLOBAL	▼	15	UnitErrFlg	Bit	... VAR_GLOBAL	▼	16	UnitErrCode	Word [Signed]	... VAR_GLOBAL	▼	17	UnitAlarmCode	Word [Signed]	... VAR_GLOBAL	▼		
	Label Name	Data Type	Class	Assign (Device/Label)																																																																																									
1	CH1_temperatureVal	Word [Signed]	... VAR_GLOBAL	▼ D11																																																																																									
2	CH3_temperatureVal	Word [Signed]	... VAR_GLOBAL	▼ D12																																																																																									
3	CH5_ScalingVal	Word [Signed]	... VAR_GLOBAL	▼ D13																																																																																									
4	CH7_temperatureVal	Word [Signed]	... VAR_GLOBAL	▼ D14																																																																																									
5	CH3_ProcAlmUpLimit	Bit	... VAR_GLOBAL	▼ F0																																																																																									
6	CH3_ProcAlmLowLimit	Bit	... VAR_GLOBAL	▼ F1																																																																																									
7	CH1_RateAlmUpLimit	Bit	... VAR_GLOBAL	▼ F2																																																																																									
8	CH1_RateAlmLowLimit	Bit	... VAR_GLOBAL	▼ F3																																																																																									
9	CH7disconnection	Bit	... VAR_GLOBAL	▼ F4																																																																																									
10	DigitOutValSig	Bit	... VAR_GLOBAL	▼ X10																																																																																									
11	ErrResetSig	Bit	... VAR_GLOBAL	▼ X13																																																																																									
12	ErrOperationEN	Bit	... VAR_GLOBAL	▼																																																																																									
13	ErrOperationENO	Bit	... VAR_GLOBAL	▼																																																																																									
14	ErrOperationOK	Bit	... VAR_GLOBAL	▼																																																																																									
15	UnitErrFlg	Bit	... VAR_GLOBAL	▼																																																																																									
16	UnitErrCode	Word [Signed]	... VAR_GLOBAL	▼																																																																																									
17	UnitAlarmCode	Word [Signed]	... VAR_GLOBAL	▼																																																																																									

Program examples

Program example 1

- This program is an example to read and save the measured temperature values of CH1, CH3, and CH7, and the scaling value of CH5.

(0)	DigitOutValS ig	R60TDG_1.b ModuleREAD	R60TDG_1.bConve rsionCompletedFlag	R60TDG_1.bOperating ConditionSettingReque st	R60TDG_1.uConve rsionCompletedFlag .0	MOV	R60TDG_1.stnMonitor [0].wMeasuredTemperatu reValue	CH1_temperat ureVal
	X10	X0	X0E	Y9				D11
					R60TDG_1.uConve rsionCompletedFlag .2	MOV	R60TDG_1.stnMonitor [2].wMeasuredTemperatu reValue	CH3_temperat ureVal
					R60TDG_1.uConve rsionCompletedFlag .4	MOV	R60TDG_1.stnMonitor [4].wScalingValue	CH5_ScalingV al
					R60TDG_1.uConve rsionCompletedFlag .6	MOV	R60TDG_1.stnMonitor [6].wMeasuredTemperatu reValue	CH7_temperat ureVal
								D12
								D13
								D14
(84)								{END}

(0) CH1 Measured temperature value, CH3 Measured temperature value, CH5 Scaling value, and CH7 Measured temperature value are to be read.

Program example 2

- This program is an example to perform the processing at the time of the issuance of a process alarm upper/lower limit alert in CH3.

(0)	R60TDG_1.uWarningOutp utFlagProcessAlarmUpperL imit.2					SET	CH3_ProcAlmUpLimit
							F0
(43)	R60TDG_1.uWarningOutp utFlagProcessAlarmLowerL imit.2					SET	CH3_ProcAlmLowLimit
							F1
(72)							{END}

(0) At the time when a process alarm upper limit alert is issued in CH3, the processing is to be performed.

(43) At the time when a process alarm lower limit alert is issued in CH3, the processing is to be performed.

Program example 3

- This program is an example to perform the processing at the time of the issuance of a rate alarm upper/lower limit alert in CH1.

(0)	R60TDG_1.uWarnin gOutputFlagRateAla rmUpperLimit.0					SET	CH1_RateAlmUpLi mit
							F2
(41)	R60TDG_1.uWarnin gOutputFlagRateAla rmLowerLimit.0					SET	CH1_RateAlmLow Limit
							F3
(69)							{END}

(0) At the time when a rate alarm upper limit alert is issued in CH1, the processing is to be performed.

(41) At the time when a rate alarm lower limit alert is issued in CH1, the processing is to be performed.

Program example 4

- This program is an example to perform the processing at the time of disconnection detection in CH7.

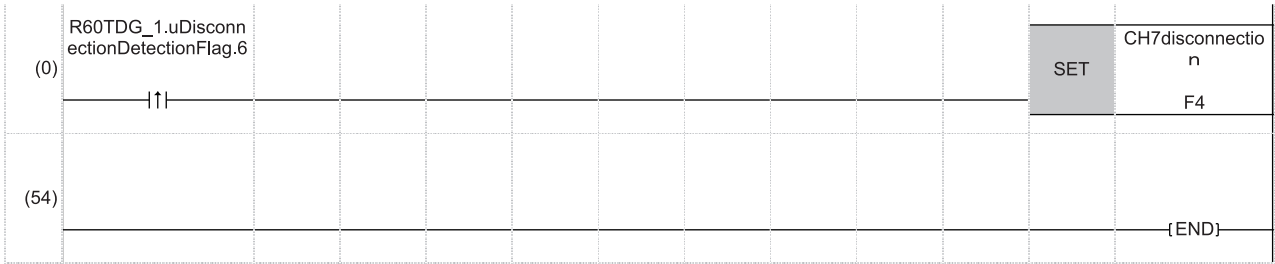

(0) At the time when disconnection is detected in CH7, the processing is to be performed.

Program example 5

- This program is an example to make the latest error code appear when disconnection is detected or an error has occurred. After this, the program clears the disconnection detection flag, error flag, and stored error code.

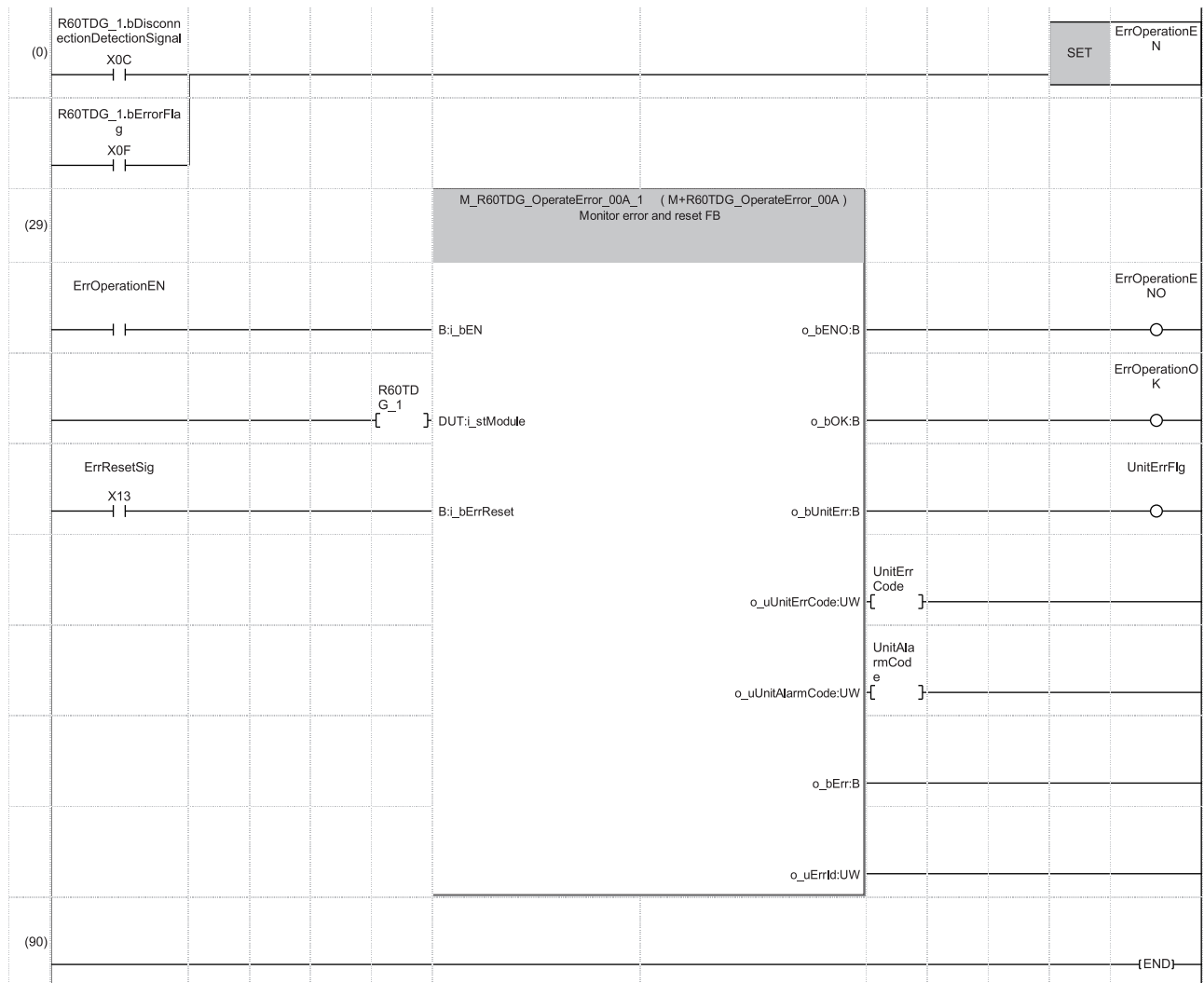

(0) Error manipulation start flag is to be turned on.

7 OFFSET/GAIN SETTING

Using the user range setting requires setting the offset and gain values.

Access to the offset/gain setting window in the engineering tool to set the offset and gain values.

7.1 Setting Procedure

The setting procedure for the offset/gain setting of a temperature input module is as follows:

[Tool] ⇒ [Module Tool List]

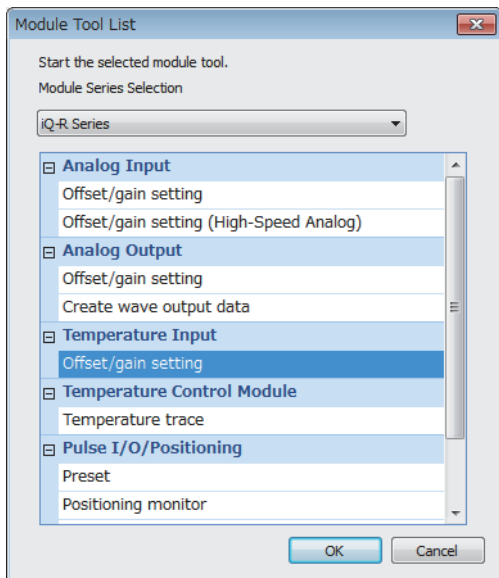

1. In "Temperature Input", select "Offset/gain setting" and click [OK] button.

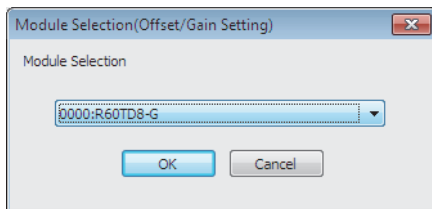

2. Select the target module for the offset/gain setting, and click [OK] button.

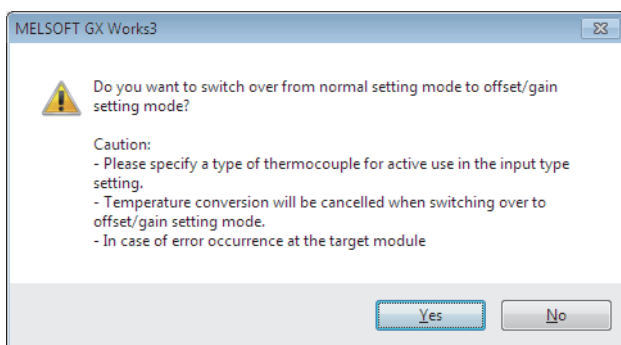

3. Click [Yes] button.

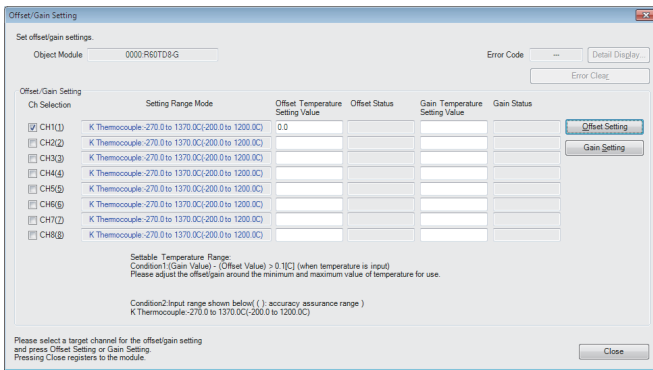

4. Check the channel where the offset/gain setting is performed.
5. Write the temperature setting value corresponding to the offset value to "Offset Temperature Setting Value".
6. Click [Offset Setting] button.

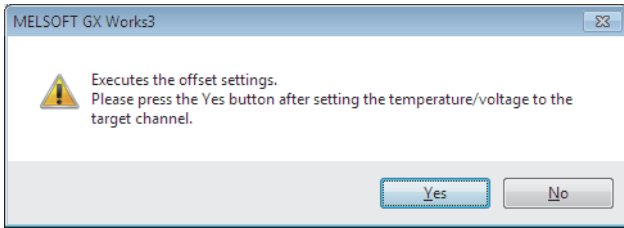

7. Apply a value that becomes an offset value to the terminal of the corresponding channel, and click [Yes] button.

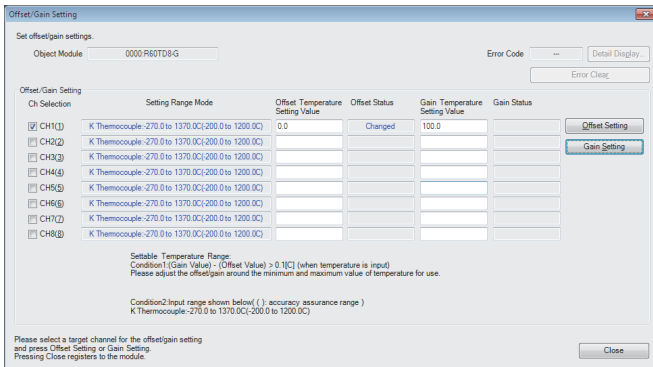

8. Check that "Offset Status" has changed to "Changed".
9. Write the temperature setting value corresponding to the gain value to "Gain Temperature Setting Value".
10. Click [Gain Setting] button.

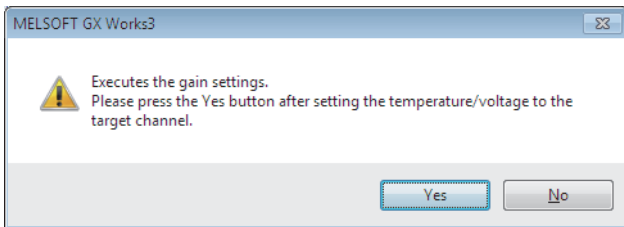

11. Apply a value that becomes a gain value to the terminal of the corresponding channel, and click [Yes] button.

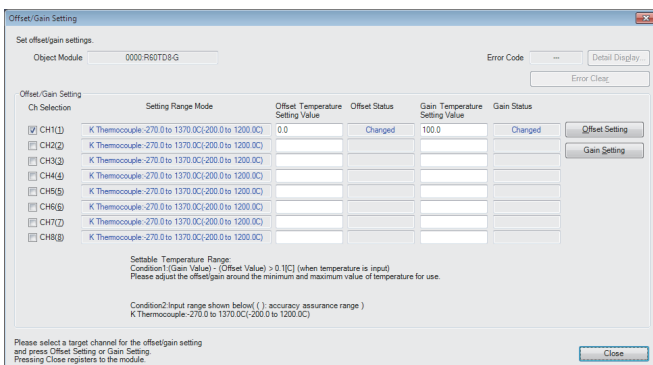

12. Check that "Gain Status" has changed to "Changed", and click [Close] button.

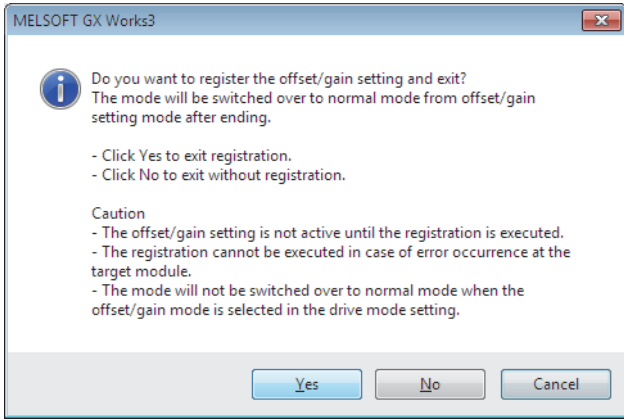

13. Click [Yes] button.

APPENDICES

Appendix 1 Accuracy

This section describes the accuracy of a temperature input module.

Accuracy of the thermocouple input module

The accuracy (°C) is calculated from the following formula.

$$A_C + T_C \times C_{OAT} + A_{CJ}$$

A_C : Conversion accuracy

T_C : Temperature characteristics

C_{OAT} : Operating ambient temperature change

A_{CJ} : Cold junction compensation accuracy

Note that the operating ambient temperature change indicates the extent to which the operating ambient temperature is out of the range of $25 \pm 5^\circ\text{C}$.

Ex.

Accuracy when B thermocouple is used, the operating ambient temperature is 35°C , and measured temperature is 1000°C
 $(\pm 1.0^\circ\text{C}) + (\pm 0.29^\circ\text{C}) \times (35^\circ\text{C} - 30^\circ\text{C}) + (\pm 1^\circ\text{C}) = \pm 3.45^\circ\text{C}$

Usable thermocouple, conversion accuracy, and effect per wiring resistance 1Ω

The following table shows the relation of usable thermocouple, conversion accuracy, and effect per wiring resistance 1Ω

Usable thermocouple	Temperature measuring range ^{*1}	Conversion accuracy (for operating ambient temperature $25 \pm 5^\circ\text{C}$)	Temperature characteristics (for 1°C of operating ambient temperature change)	Maximum temperature error at ambient temperature 55°C	Effect per wiring resistance 1Ω ^{*4}
B	0 to 600°C	— ^{*3}	— ^{*3}	— ^{*3}	— ^{*3}
	600 to 800°C ^{*2}	$\pm 1.3^\circ\text{C}$	$\pm 0.3^\circ\text{C}$	$\pm 8.8^\circ\text{C}$	$0.042^\circ\text{C}/\Omega$
	800 to 1700°C ^{*2}	$\pm 1.0^\circ\text{C}$	$\pm 0.29^\circ\text{C}$	$\pm 8.25^\circ\text{C}$	$0.036^\circ\text{C}/\Omega$
	1700 to 1820°C	— ^{*3}	— ^{*3}	— ^{*3}	— ^{*3}
R	-50 to 0°C	— ^{*3}	— ^{*3}	— ^{*3}	— ^{*3}
	0 to 300°C ^{*2}	$\pm 1.5^\circ\text{C}$	$\pm 0.4^\circ\text{C}$	$\pm 11.5^\circ\text{C}$	$0.05^\circ\text{C}/\Omega$
	300 to 1600°C ^{*2}	$\pm 0.8^\circ\text{C}$	$\pm 0.29^\circ\text{C}$	$\pm 8.05^\circ\text{C}$	$0.028^\circ\text{C}/\Omega$
	1600 to 1760°C	— ^{*3}	— ^{*3}	— ^{*3}	— ^{*3}
S	-50 to 0°C	— ^{*3}	— ^{*3}	— ^{*3}	— ^{*3}
	0 to 300°C ^{*2}	$\pm 1.5^\circ\text{C}$	$\pm 0.4^\circ\text{C}$	$\pm 11.5^\circ\text{C}$	$0.05^\circ\text{C}/\Omega$
	300 to 1600°C ^{*2}	$\pm 0.8^\circ\text{C}$	$\pm 0.29^\circ\text{C}$	$\pm 8.05^\circ\text{C}$	$0.028^\circ\text{C}/\Omega$
	1600 to 1760°C	— ^{*3}	— ^{*3}	— ^{*3}	— ^{*3}
K	-270 to -200°C	— ^{*3}	— ^{*3}	— ^{*3}	— ^{*3}
	-200 to 0°C ^{*2}	$\pm 0.5^\circ\text{C}$	$\pm 0.06^\circ\text{C}$, or a larger value of -0.1% or $+0.1\%$ of measured temperature	$\pm 5.5^\circ\text{C}$	$0.017^\circ\text{C}/\Omega$
	0 to 1200°C ^{*2}	$\pm 0.3^\circ\text{C}$	$\pm 0.06^\circ\text{C}$, or a larger value of -0.02% or $+0.02\%$ of measured temperature	$\pm 6.3^\circ\text{C}$	$0.007^\circ\text{C}/\Omega$
	1200 to 1370°C	— ^{*3}	— ^{*3}	— ^{*3}	— ^{*3}
E	-270 to -200°C	— ^{*3}	— ^{*3}	— ^{*3}	— ^{*3}
	-200 to 0°C ^{*2}	$\pm 0.5^\circ\text{C}$	$\pm 0.06^\circ\text{C}$, or a larger value of -0.15% or $+0.15\%$ of measured temperature	$\pm 8.0^\circ\text{C}$	$0.01^\circ\text{C}/\Omega$
	0 to 900°C ^{*2}	$\pm 0.2^\circ\text{C}$	$\pm 0.06^\circ\text{C}$, or a larger value of -0.02% or $+0.02\%$ of measured temperature	$\pm 4.7^\circ\text{C}$	$0.005^\circ\text{C}/\Omega$
	900 to 1000°C	— ^{*3}	— ^{*3}	— ^{*3}	— ^{*3}

Usable thermocouple	Temperature measuring range ^{*1}	Conversion accuracy (for operating ambient temperature 25±5°C)	Temperature characteristics (for 1°C of operating ambient temperature change)	Maximum temperature error at ambient temperature 55°C	Effect per wiring resistance 1Ω ^{*4}
J	-210 to -40°C	— ^{*3}	— ^{*3}	— ^{*3}	— ^{*3}
	-40 to 750°C ^{*2}	±0.2°C	±0.06°C, or a larger value of -0.02% or +0.02% of measured temperature	±3.95°C	0.006°C/Ω
	750 to 1200°C	— ^{*3}	— ^{*3}	— ^{*3}	— ^{*3}
T	-270 to -200°C	— ^{*3}	— ^{*3}	— ^{*3}	— ^{*3}
	-200 to 0°C ^{*2}	±0.5°C	±0.06°C, or a larger value of -0.1% or +0.1% of measured temperature	±5.5°C	0.016°C/Ω
	0 to 350°C ^{*2}	±0.4°C	±0.06°C, or a larger value of -0.02% or +0.02% of measured temperature	±2.15°C	0.007°C/Ω
	350 to 400°C	— ^{*3}	— ^{*3}	— ^{*3}	— ^{*3}
N	-270 to -200°C	— ^{*3}	— ^{*3}	— ^{*3}	— ^{*3}
	-200 to 0°C ^{*2}	±0.5°C	±0.06°C, or a larger value of -0.2% or +0.2% of measured temperature	±6.2°C	0.025°C/Ω
	0 to 1250°C ^{*2}	±0.5°C	±0.06°C, or a larger value of -0.02% or +0.02% of measured temperature	±6.75°C	0.01°C/Ω
	1250 to 1300°C	— ^{*3}	— ^{*3}	— ^{*3}	— ^{*3}

*1 If a value outside the temperature measuring range in the table is input from a thermocouple, the value is regarded as the maximum value or minimum value of the temperature measuring range.

*2 The accuracy is applied to only the temperature range of class 1 to 3 of JIS C 1602-1995.

*3 The accuracy is not guaranteed though temperature measurement is possible.

*4 The value indicates a temperature error generated per wiring resistance 1Ω of a thermocouple. Check the resistance value and calculate the temperature error of the system. If the error is beyond the allowable range of the system used, correct the measured temperature value with the offset/gain setting.

Accuracy of the RTD input module

The accuracy (°C) is calculated from the following formula.

$$A_C + A_{L_{RTD}}$$

A_C : Conversion accuracy

$A_{L_{RTD}}$: Allowance of the resistance temperature detector used

- Allowance of Pt100 (JIS C 1604-1997, IEC 751:1983)

Class	Allowance
A	$\pm(0.15 + 0.002 t)^{\circ}\text{C}$
B	$\pm(0.3 + 0.005 t)^{\circ}\text{C}$

- Allowance of JPt100 and Pt50 (JIS C 1604-1981)

Class	Allowance
0.15	$\pm(0.15 + 0.0015 t)^{\circ}\text{C}$
0.2	$\pm(0.15 + 0.002 t)^{\circ}\text{C}$
0.5	$\pm(0.3 + 0.005 t)^{\circ}\text{C}$

- Allowance of Ni100 (DIN 43760 1987)

Class	Allowance
0 to 250°C	$\pm(0.4 + 0.007 t)^{\circ}\text{C}$
-60 to 0°C	$\pm(0.4 + 0.0028 t)^{\circ}\text{C}$

Appendix 2 External Dimensions

The following figure shows the external dimensions of a temperature input module.

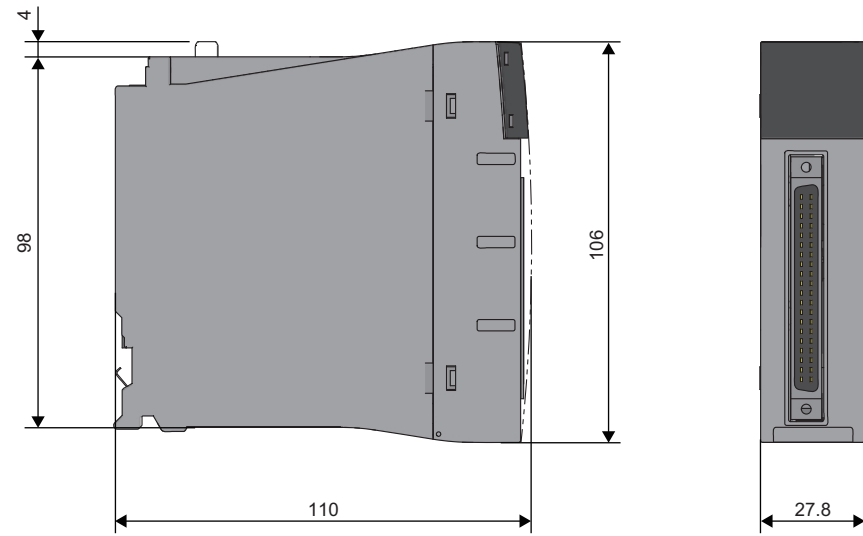

(Unit: mm)

A

INDEX

0 to 9

- 40-pin connector crimping tool 23
- 40-pin connectors 23

A

- Accuracy 40
- ALM LED 15

C

- Cold junction compensation resistor (RTD) 14
- Connector for external devices 15,23

E

- ERR LED 15
- External dimensions 43
- External wiring examples 26

O

- Offset/gain setting 37

P

- Performance specifications 17
- Production information marking 15
- Program examples 31

R

- RTD input module 14
- RUN LED 15

S

- Signal layout of connectors for external devices . . 24

T

- Temperature input module 14
- Thermocouple input module 14

MEMO

REVISIONS

*The manual number is given on the bottom left of the back cover.

Revision date	*Manual number	Description
January 2015	SH(NA)-081493ENG-A	First edition
March 2016	SH(NA)-081493ENG-B	■Added or modified parts RELEVANT MANUALS, Chapter 4, Section 5.2, 7.1, Appendix 1, 2

Japanese manual number: SH-081492-B

This manual confers no industrial property rights of any other kind, nor does it confer any patent licenses. Mitsubishi Electric Corporation cannot be held responsible for any problems involving industrial property rights which may occur as a result of using the contents noted in this manual.

© 2015 MITSUBISHI ELECTRIC CORPORATION

WARRANTY

Please confirm the following product warranty details before using this product.

1. Gratis Warranty Term and Gratis Warranty Range

If any faults or defects (hereinafter "Failure") found to be the responsibility of Mitsubishi occurs during use of the product within the gratis warranty term, the product shall be repaired at no cost via the sales representative or Mitsubishi Service Company.

However, if repairs are required onsite at domestic or overseas location, expenses to send an engineer will be solely at the customer's discretion. Mitsubishi shall not be held responsible for any re-commissioning, maintenance, or testing on-site that involves replacement of the failed module.

[Gratis Warranty Term]

The gratis warranty term of the product shall be for one year after the date of purchase or delivery to a designated place. Note that after manufacture and shipment from Mitsubishi, the maximum distribution period shall be six (6) months, and the longest gratis warranty term after manufacturing shall be eighteen (18) months. The gratis warranty term of repair parts shall not exceed the gratis warranty term before repairs.

[Gratis Warranty Range]

- (1) The range shall be limited to normal use within the usage state, usage methods and usage environment, etc., which follow the conditions and precautions, etc., given in the instruction manual, user's manual and caution labels on the product.
- (2) Even within the gratis warranty term, repairs shall be charged for in the following cases.
 1. Failure occurring from inappropriate storage or handling, carelessness or negligence by the user. Failure caused by the user's hardware or software design.
 2. Failure caused by unapproved modifications, etc., to the product by the user.
 3. When the Mitsubishi product is assembled into a user's device, Failure that could have been avoided if functions or structures, judged as necessary in the legal safety measures the user's device is subject to or as necessary by industry standards, had been provided.
 4. Failure that could have been avoided if consumable parts (battery, backlight, fuse, etc.) designated in the instruction manual had been correctly serviced or replaced.
 5. Failure caused by external irresistible forces such as fires or abnormal voltages, and Failure caused by force majeure such as earthquakes, lightning, wind and water damage.
 6. Failure caused by reasons unpredictable by scientific technology standards at time of shipment from Mitsubishi.
 7. Any other failure found not to be the responsibility of Mitsubishi or that admitted not to be so by the user.

2. Onerous repair term after discontinuation of production

- (1) Mitsubishi shall accept onerous product repairs for seven (7) years after production of the product is discontinued. Discontinuation of production shall be notified with Mitsubishi Technical Bulletins, etc.
- (2) Product supply (including repair parts) is not available after production is discontinued.

3. Overseas service

Overseas, repairs shall be accepted by Mitsubishi's local overseas FA Center. Note that the repair conditions at each FA Center may differ.

4. Exclusion of loss in opportunity and secondary loss from warranty liability

Regardless of the gratis warranty term, Mitsubishi shall not be liable for compensation to:

- (1) Damages caused by any cause found not to be the responsibility of Mitsubishi.
- (2) Loss in opportunity, lost profits incurred to the user by Failures of Mitsubishi products.
- (3) Special damages and secondary damages whether foreseeable or not, compensation for accidents, and compensation for damages to products other than Mitsubishi products.
- (4) Replacement by the user, maintenance of on-site equipment, start-up test run and other tasks.

5. Changes in product specifications

The specifications given in the catalogs, manuals or technical documents are subject to change without prior notice.

TRADEMARKS

The company names, system names and product names mentioned in this manual are either registered trademarks or trademarks of their respective companies.

In some cases, trademark symbols such as '™' or '®' are not specified in this manual.

SH(NA)-081493ENG-B(1603)MEE

MODEL: R60TDG-R60RDG-U-IN-E

MODEL CODE: 13JX33

MITSUBISHI ELECTRIC CORPORATION

HEAD OFFICE : TOKYO BUILDING, 2-7-3 MARUNOUCHI, CHIYODA-KU, TOKYO 100-8310, JAPAN
NAGOYA WORKS : 1-14, YADA-MINAMI 5-CHOME, HIGASHI-KU, NAGOYA, JAPAN

When exported from Japan, this manual does not require application to the
Ministry of Economy, Trade and Industry for service transaction permission.

Specifications subject to change without notice.